

## Chapter 7 Parametric Modeling Fundamentals - Autodesk Inventor

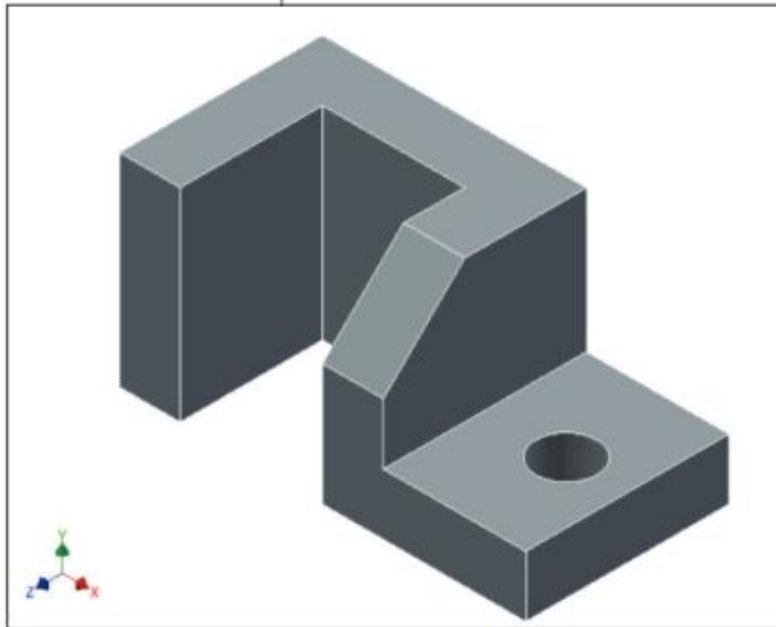

### Learning Objectives

- ◆ Create Simple Extruded Solid Models
- ◆ Understand the Basic Parametric Modeling Procedure
- ◆ Create 2D Sketches
- ◆ Understand the “Shape before Size” Approach
- ◆ Use the Dynamic Viewing Commands
- ◆ Create and Edit Parametric Dimensions

## Getting Started with Autodesk Inventor



Autodesk Inventor is composed of several application software modules (these modules are called *applications*) all sharing a common database. In this text, the main concentration is placed on the solid modeling modules used for part design. The general procedures required in creating solid models, engineering drawings, and assemblies are illustrated.

How to start Autodesk Inventor depends on the type of workstation and the particular software configuration you are using. With most *Windows* systems, you may select **Autodesk Inventor** on the *Start* menu or select the **Autodesk Inventor** icon on the desktop. Consult your instructor or technical support personnel if you have difficulty starting the software. The program takes a while to load, so be patient.

The tutorials in this text are based on the assumption that you are using Autodesk Inventor's default settings. If your system has been customized for other uses, contact your technical support personnel to restore the default software configuration.

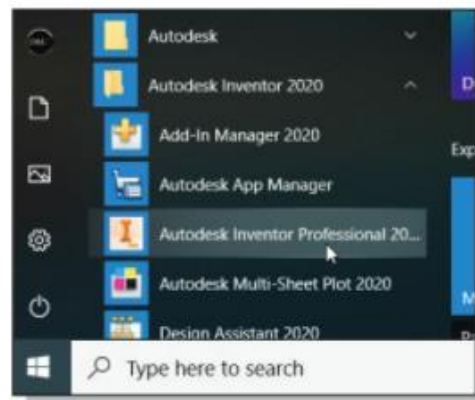

## The Screen Layout and Getting Started Toolbar

Once the program is loaded into the memory, the Inventor window appears on the screen with the *Get Started* toolbar options activated.

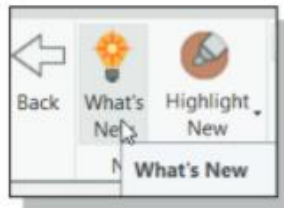
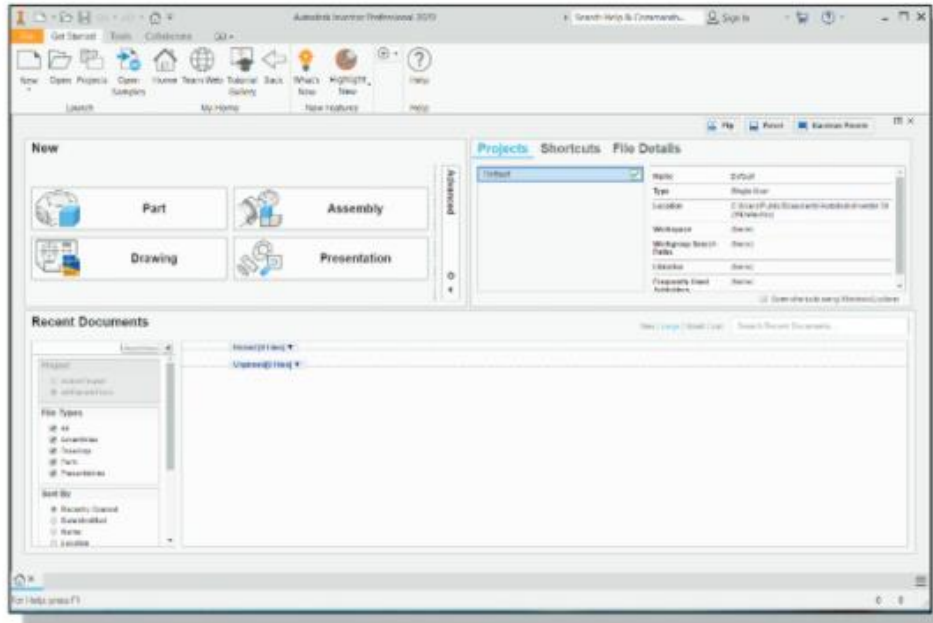

- ❖ Note that the *Get Started* toolbar contains helpful information in regard to using the Inventor software. For example, clicking the **What's New** option will bring up the *Internet Browser*, which contains the list of new features that are included in this release of Autodesk Inventor.

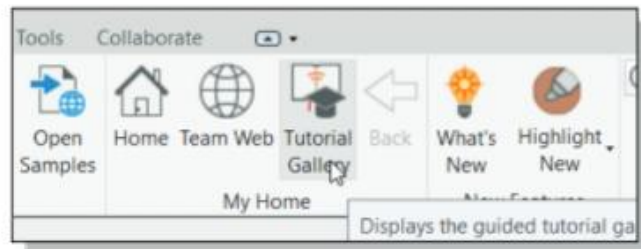

- ❖ You are encouraged to browse through the general introduction available in the *Videos and Tutorials* section.

## The New File Dialog Box and Units Setup

When starting a new CAD file, the first thing we should do is to choose the units we would like to use. We will use the English (feet and inches) setting for this example.

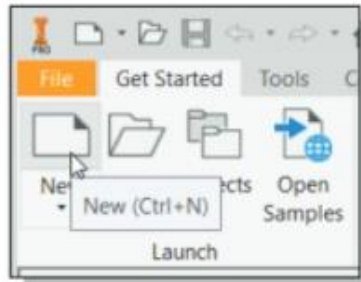

1. Select the **New** icon with a single click of the left-mouse-button in the *Launch* toolbar.

❖ Note that the **New** option allows us to start a new modeling task, which can be creating a new model or several other modeling tasks.

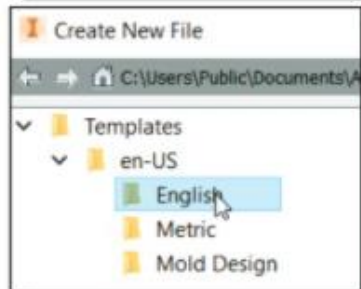

2. Select the **en-US->English** tab in the *New File* dialog box as shown. Note the default tab contains the file options which are based on the default units chosen during installation.

3. Select the **Standard(in).ipt** icon as shown. The different icons are templates for the different modeling tasks. The **idw** file type stands for drawing file, the **iam** file type stands for assembly file, and the **ipt** file type stands for part file. The **ipn** file type stands for assembly presentation.

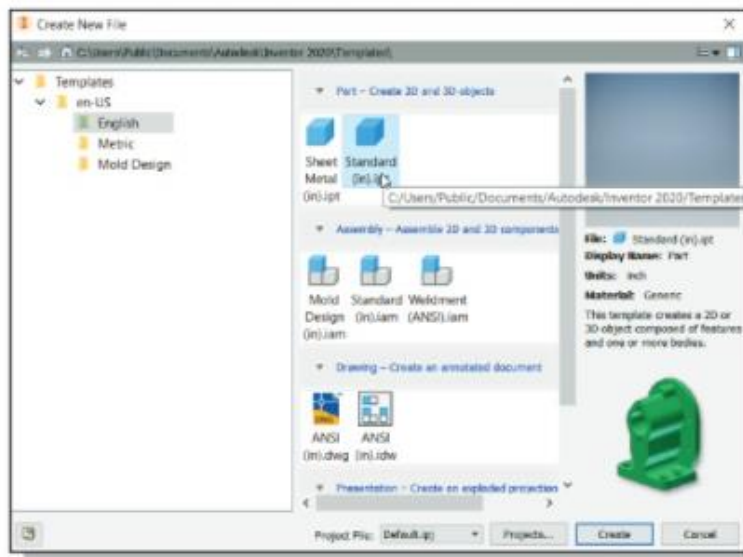

4. Click **Create** in the *Create New File* dialog box to accept the selected settings.

## The Default Autodesk Inventor Screen Layout

The default Autodesk Inventor drawing screen contains the *pull-down* menus, the *Standard* toolbar, the *Features* toolbar, the *Sketch* toolbar, the *drawing* area, the *browser* area, and the *Status Bar*. A line of quick text appears next to the icon as you move the *mouse cursor* over different icons. You may resize the Autodesk Inventor drawing window by clicking and dragging the edges of the window, or relocate the window by clicking and dragging the window title area.

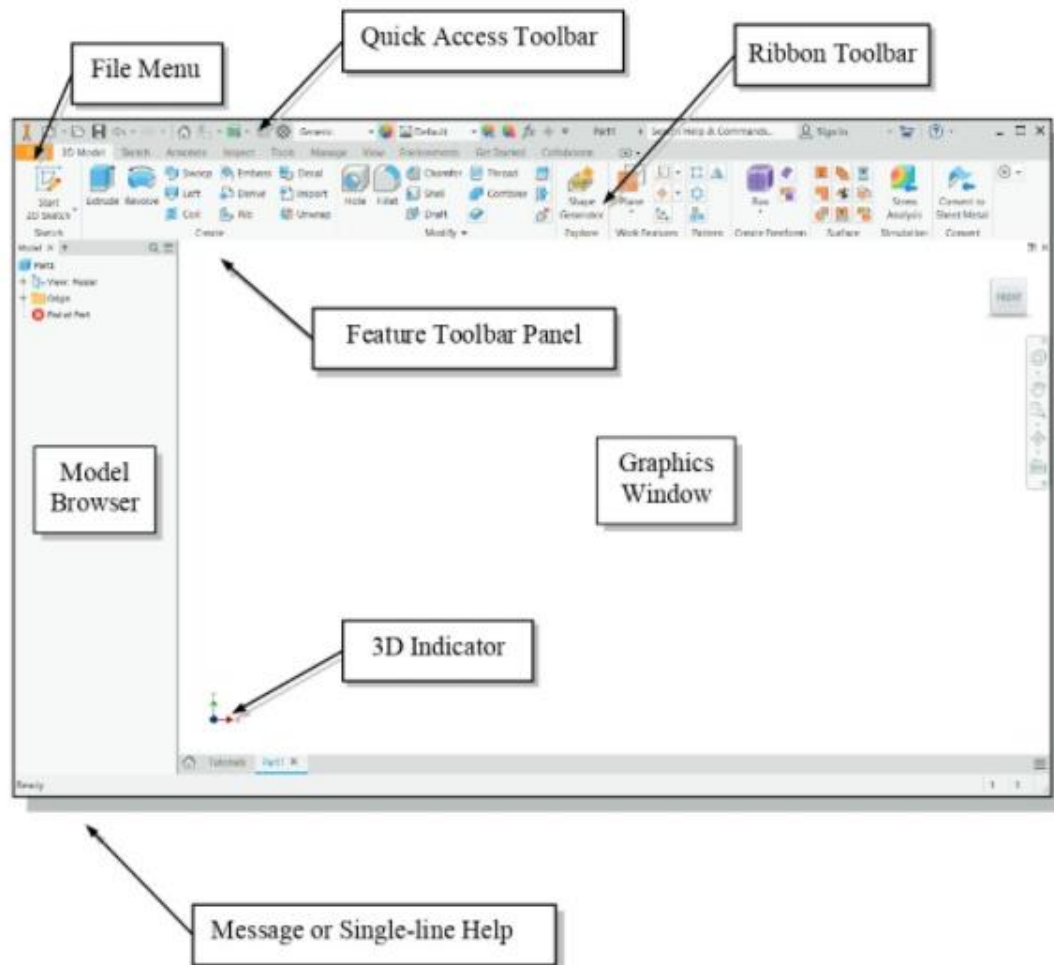

- The **Ribbon Toolbar** is a relatively new feature in Autodesk Inventor; the **Ribbon Toolbar** is composed of a series of tool panels, which are organized into tabs labeled by task. The **Ribbon** provides a compact palette of all of the tools necessary to accomplish the different modeling tasks. The drop-down arrow next to any icon indicates additional commands are available on the expanded panel; access the expanded panel by clicking on the drop-down arrow.



- **File Menu**

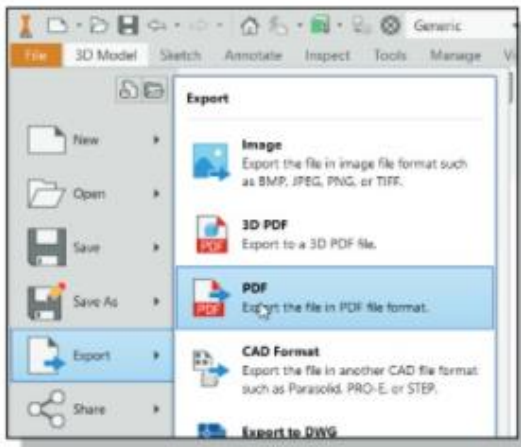

The *File* menu at the upper left corner of the main window contains tools for all file-related operations, such as Open, Save, Export, etc.

- **Quick Access Toolbar**

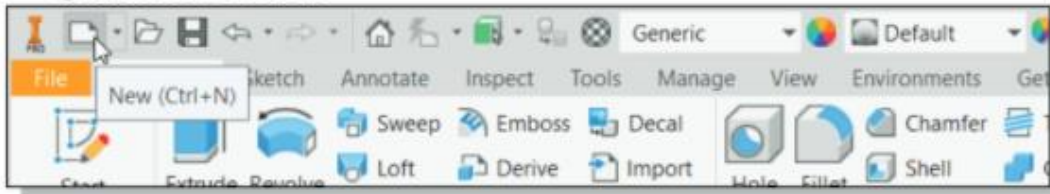

The *Quick Access* toolbar at the top of the *Inventor* window allows us quick access to file-related commands and to Undo/Redo the last operations.

- **Ribbon Tabs and Tool panels**

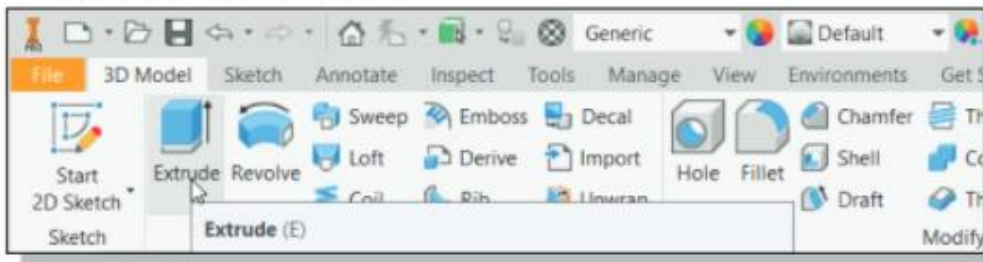

The *Ribbon* is composed of a series of tool panels, which are organized into tabs labeled by task. The assortments of tool panels can be accessed by clicking on the tabs.

- **Online Help Panel**

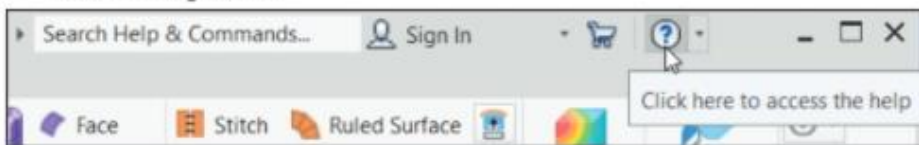

The *Help* options panel provides us with multiple options to access online help for Autodesk Inventor. The *Online Help system* provides general help information, such as command options and command references.

- **3D Model Toolbar**

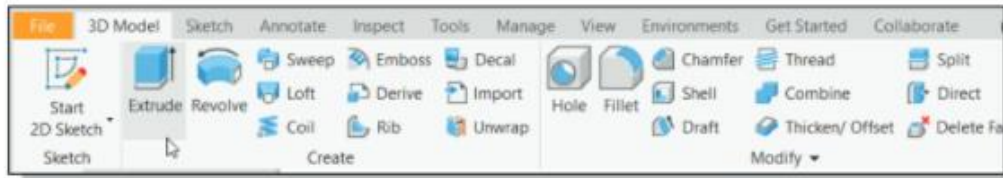

The *3D Model* toolbar provides tools for creating the different types of 3D features, such as *Extrude*, *Revolve*, *Sweep*, etc.

- **Graphics Window**



The *graphics window* is the area where models and drawings are displayed.

- **Message and Status Bar**

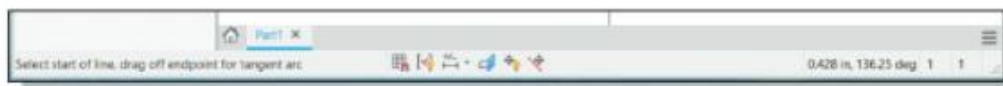

The *Message and Status Bar* area shows a single-line help when the cursor is on top of an icon. This area also displays information pertinent to the active operation. For example, in the figure above, the coordinates and length information of a line are displayed while the *Line* command is activated.

## Mouse Buttons

Autodesk Inventor utilizes the mouse buttons extensively. In learning Autodesk Inventor's interactive environment, it is important to understand the basic functions of the mouse buttons. It is highly recommended that you use a mouse or a tablet with Autodesk Inventor since the package uses the buttons for various functions.

- **Left mouse button**

The **left mouse button** is used for most operations, such as selecting menus and icons, or picking graphic entities. One click of the button is used to select icons, menus and form entries, and to pick graphic items.

- **Right mouse button**

The **right mouse button** is used to bring up additional available options. The software also utilizes the **right mouse button** the same as the **ENTER** key and is often used to accept the default setting to a prompt or to end a process.

- **Middle mouse button/wheel**

The middle mouse button/wheel can be used to **Pan** (hold down the wheel button and drag the mouse) or **Zoom** (turn the wheel) realtime.

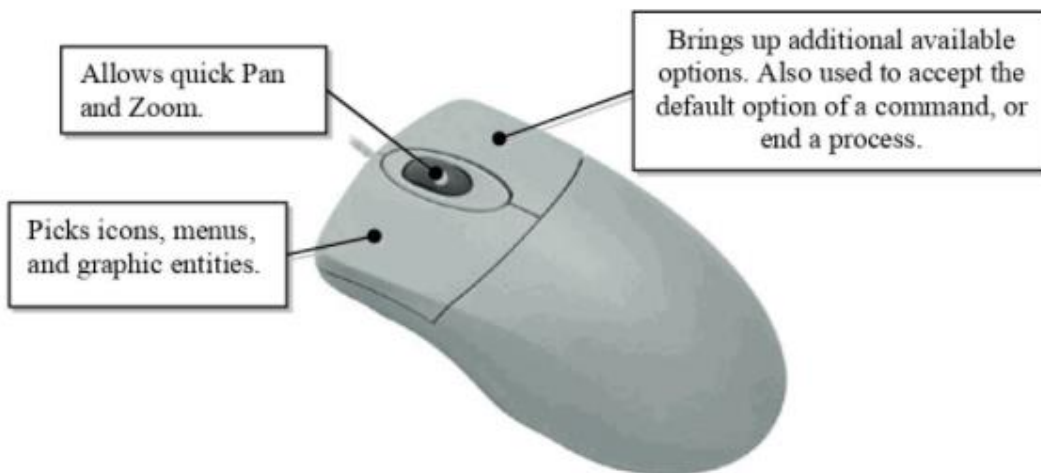

## [Esc] – Canceling Commands

The **[Esc]** key is used to cancel a command in Autodesk Inventor. The **[Esc]** key is located near the top-left corner of the keyboard. Sometimes, it may be necessary to press the **[Esc]** key twice to cancel a command; it depends on where we are in the command sequence. For some commands, the **[Esc]** key is used to exit the command.



## Autodesk Inventor Help System

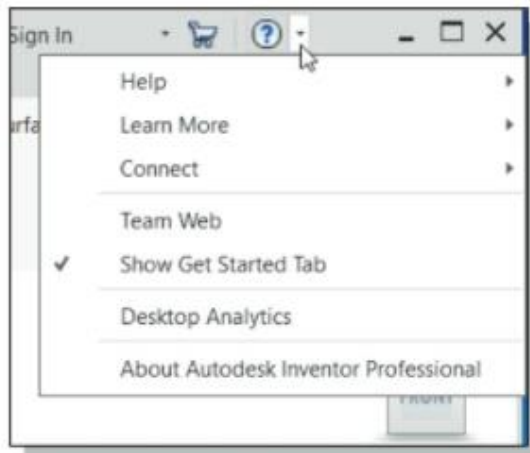

❖ Several types of help are available at any time during an Autodesk Inventor session. Autodesk Inventor provides many help functions, such as:

- Use the **Help** button near the upper right corner of the *Inventor* window.
- Help quick-key: Press the [F1] key to access the *Inventor Help system*.



- Use the **Info Center** to get information on a specific topic.

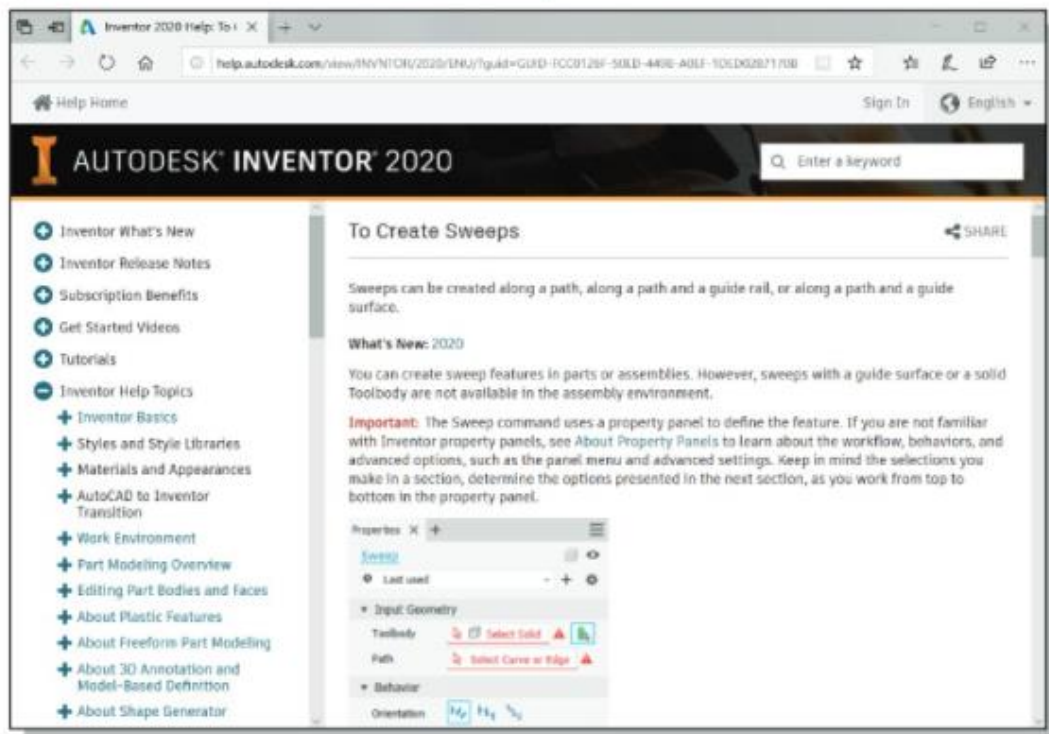

- Use the Internet to access information on the Autodesk community website.

## Data Management Using Inventor Project files

With Autodesk Inventor, it is quite feasible to create designs without any regard to using the Autodesk Inventor data management system. Data management becomes critical for projects involving complex designs, especially when multiple team members are involved, or when we are working on integrating multiple design projects, or when it is necessary to share files among the design projects. Autodesk Inventor provides a fairly flexible data management system. It allows one person to use the basic option to help manage the locations of the different design files, or a team of designers can use the data management system to manage their projects stored on a networked computer system.

The Autodesk Inventor data management system organizes files based on **projects**. Each project is identified with a main folder that can contain files and folders associated to the design. In Autodesk Inventor, a *project* file (.ipj) defines the locations of all files associated with the project, including templates and library files.

The Autodesk Inventor data management system uses two types of projects:

- **Single-user Project**
- **Autodesk Vault Project** (installation of *Autodesk Vault* software is required)

The *single-user project* is for simpler projects where all project files are located on the same computer. The *Autodesk Vault project* is more suitable for projects requiring multiple users using a networked computer system.

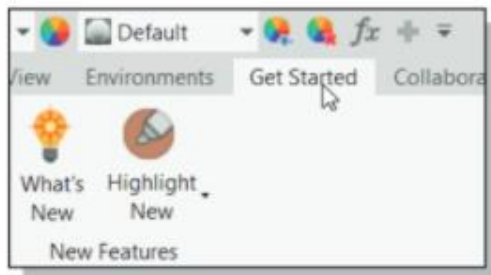

1. Click on the **Get Started** tab, with the left-mouse-button, in the *Ribbon* toolbar.
- ❖ Note the **Get Started** tab is the default panel displayed during startup.

2. Click on the **Projects** icon with a single click of the left-mouse-button in the *Launch* toolbar.

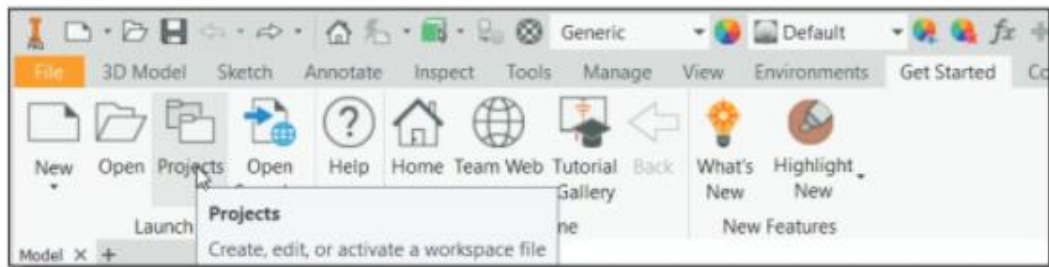

- ❖ The **Projects Editor** appears on the screen. Note that several options are available to access the *Editor*; it can also be accessed through the **Open file** command.

- ❖ In the *Projects Editor*: the **Default** project is available.

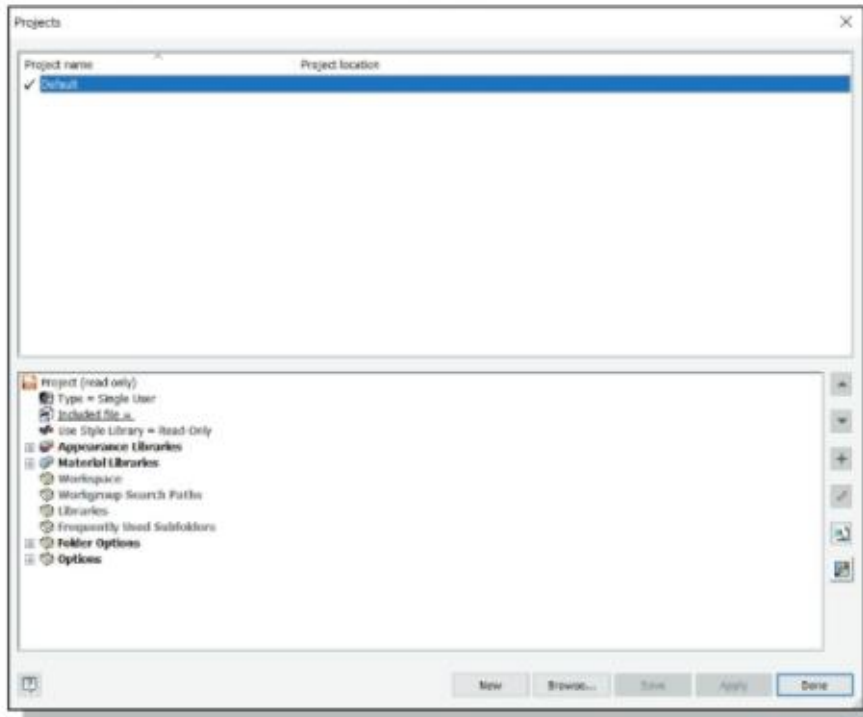

The **Default** project is automatically active by default, and the *default project* does not define any location for files. In other words, the data management system is not used. Using the *default project*, designs can still be created and modified, and any model file can be opened and saved anywhere without regard to project and file management.

## Setup of a New Inventor Project

In this section, we will create a new *Inventor* project for the chapters of this book using the *Inventor* built-in **Single User Project** option. Note that it is also feasible to create a separate project for each chapter.

1. Click **New** to begin the setup of a new *project file*.



2. The *Inventor project wizard* appears on the screen; select the **New Single User Project** option as shown.

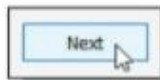

3. Click **Next** to proceed with the next setup option.
4. In the *Project File Name* input box, enter **Parametric-Modeling** as the name of the new project.

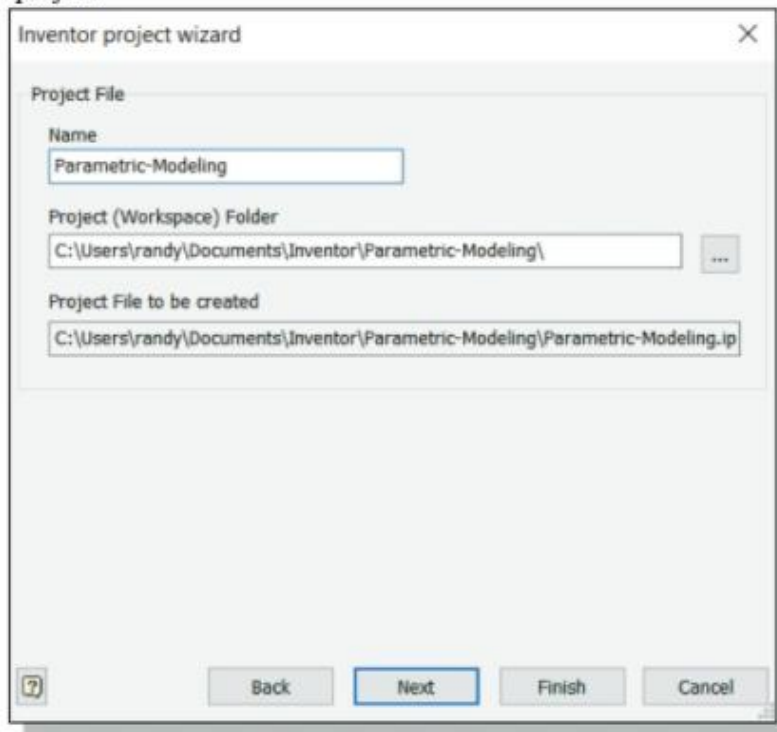

5. In the *Project Folder* input box, note the default folder location, such as **C:\Users\Documents\Inventor \Parametric Modeling\**; choose a preferred folder name as the folder name of the new project.

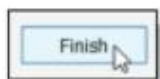

6. Click **Finish** to proceed with the creation of the new project.

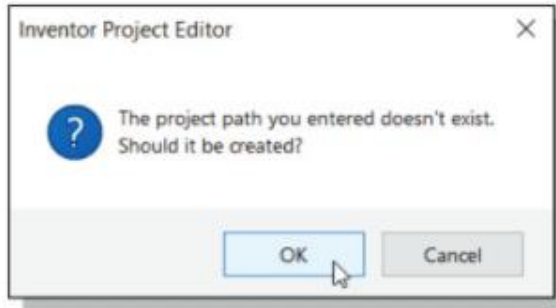

7. A *warning message* appears on the screen, indicating the specified folder does not exist. Click **OK** to create the folder.

8. A second *warning message* appears on the screen, indicating that the newly created project cannot be made active since an *Inventor* file is open. Click **OK** to close the message dialog box.

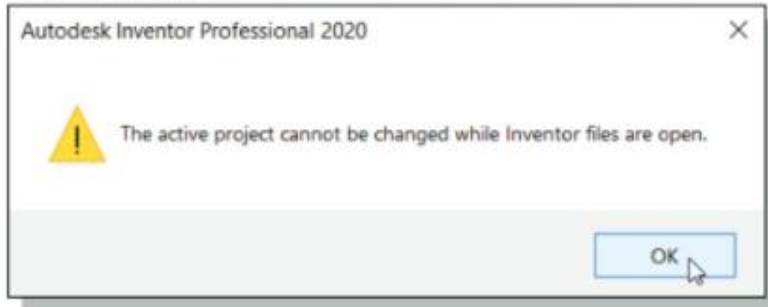

- The new project has been created and its name appears in the project list area as shown in the figure.

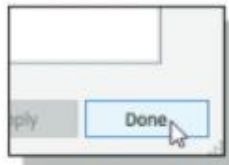
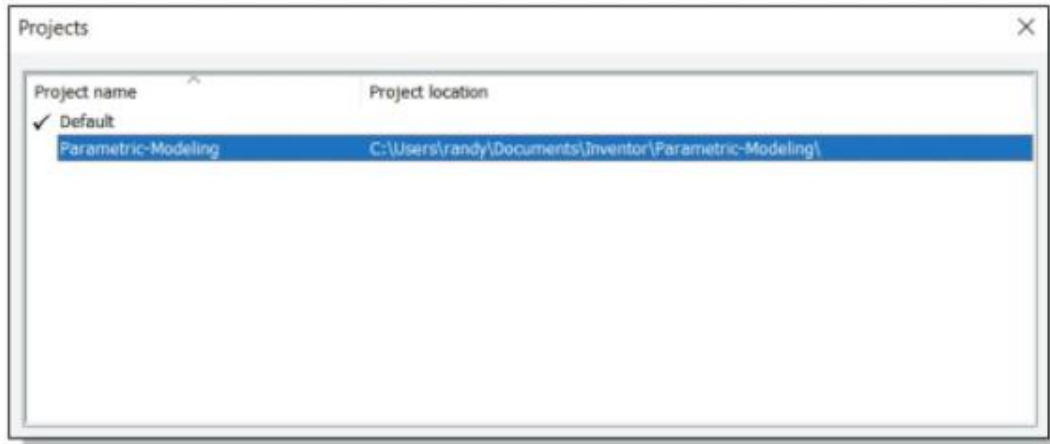

9. Click **Done** to exit the *Inventor Projects Editor* option.



## The Content of the Inventor Project File

An *Inventor* project file is actually a text file in .xml format with an .ipj extension. The file specifies the paths to the folder containing the files in the project. To assure that links between files work properly, it is advised to add the locations for folders to the project file before working on model files.

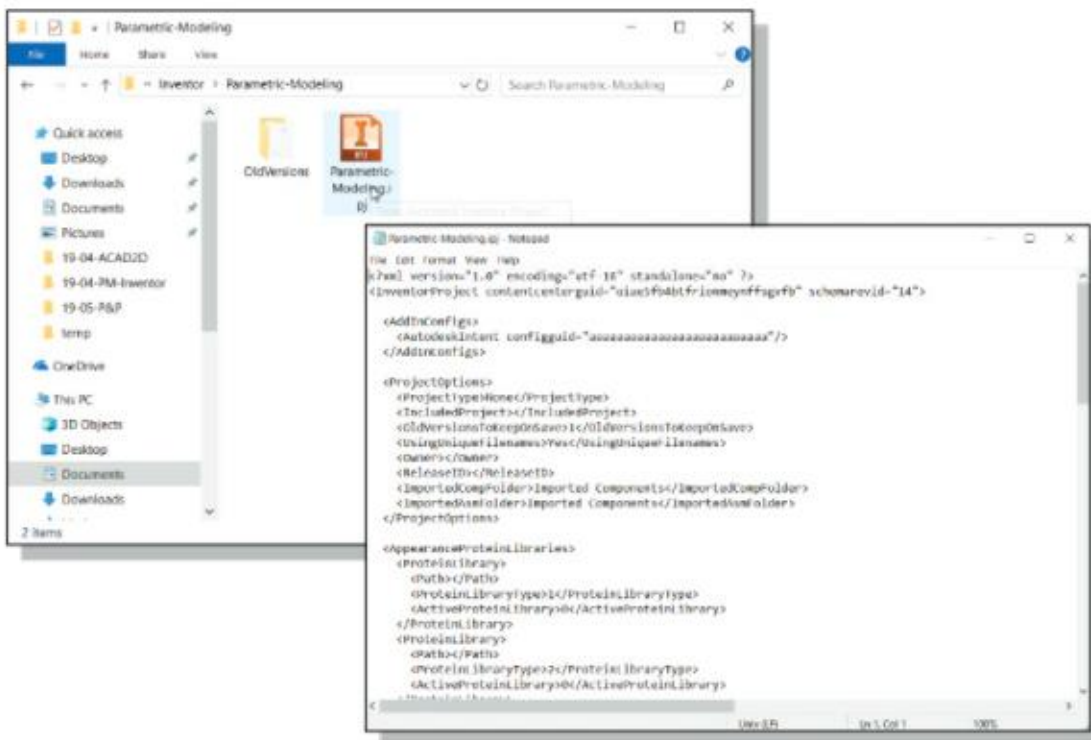

## Leaving Autodesk Inventor

To leave the *Application* menu, use the left-mouse-button and click on **Exit Autodesk Inventor** from the pull-down menu.

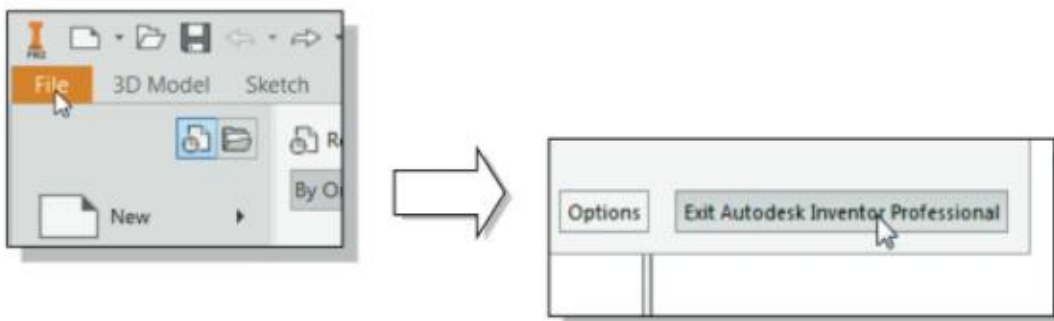

## Feature-Based Parametric Modeling

The **feature-based parametric modeling** technique enables the designer to incorporate the original **design intent** into the construction of the model. The word *parametric* means the geometric definitions of the design, such as dimensions, can be varied at any time in the design process. Parametric modeling is accomplished by identifying and creating the key features of the design with the aid of computer software. The design variables, described in the sketches as parametric relations, can then be used to quickly modify/update the design.

In Autodesk Inventor, the parametric part modeling process involves the following steps:

1. **Create a rough two-dimensional sketch of the basic shape of the base feature of the design.**
2. **Apply/modify constraints and dimensions to the two-dimensional sketch.**
3. **Extrude, revolve, or sweep the parametric two-dimensional sketch to create the base solid feature of the design.**
4. **Add additional parametric features by identifying feature relations and complete the design.**
5. **Perform analyses on the computer model and refine the design as needed.**
6. **Create the desired drawing views to document the design.**

The approach of creating two-dimensional sketches of the three-dimensional features is an effective way to construct solid models. Many designs are in fact the same shape in one direction. Computer input and output devices we use today are largely two-dimensional in nature, which makes this modeling technique quite practical. This method also conforms to the design process that helps the designer with conceptual design along with the capability to capture the *design intent*. Most engineers and designers can relate to the experience of making rough sketches on restaurant napkins to convey conceptual design ideas. Autodesk Inventor provides many powerful modeling and design tools, and there are many different approaches to accomplishing modeling tasks. The basic principle of **feature-based modeling** is to build models by adding simple features one at a time. In this chapter, the general parametric part modeling procedure is illustrated; a very simple solid model with extruded features is used to introduce the Autodesk Inventor user interface. The display viewing functions and the basic two-dimensional sketching tools are also demonstrated.

## The Adjuster Design

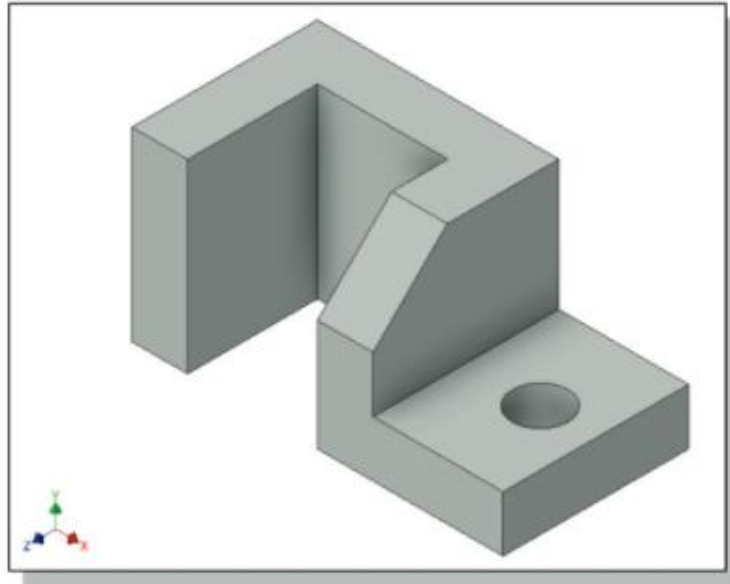

## Starting Autodesk Inventor

1. Select the **Autodesk Inventor** option on the *Start* menu or select the **Autodesk Inventor** icon on the desktop to start Autodesk Inventor. The Autodesk Inventor main window will appear on the screen.

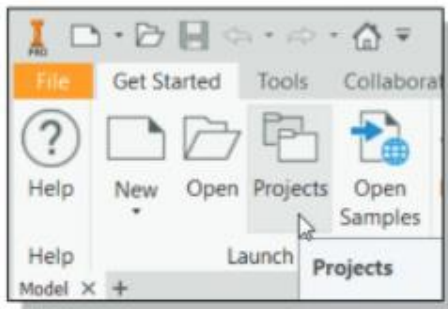
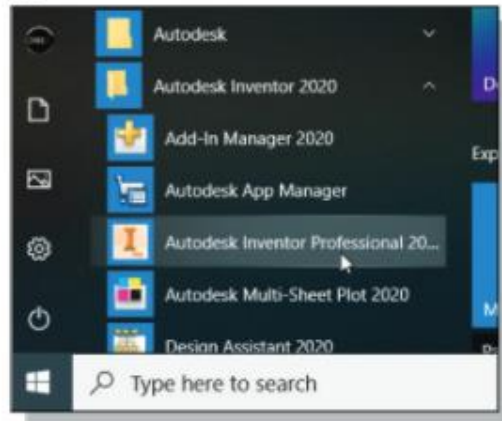

2. Select the **Projects** icon with a single click of the left-mouse-button.

3. In the *Projects List*, **double-click** on the **Parametric-Modeling** project name to activate the project as shown.

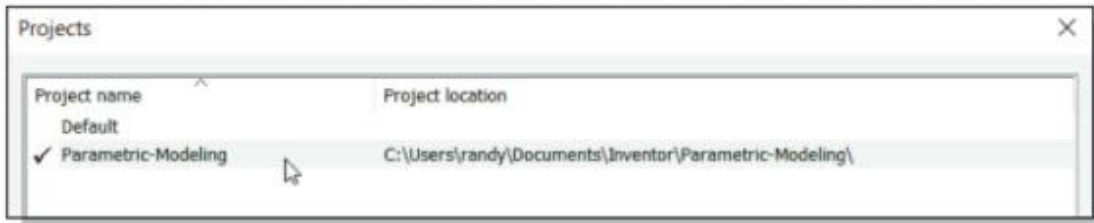

- Note that Autodesk Inventor will keep this activated project as the default project until another project is activated.

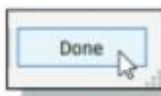

4. Click **Done** to accept the setting and end the *Projects Editor*.

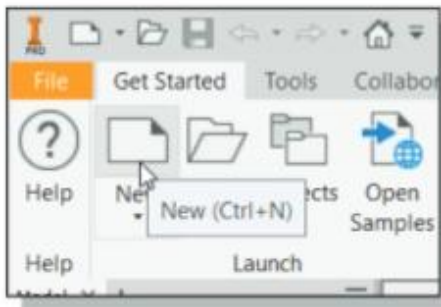

5. Select the **New File** icon with a single click of the left-mouse-button.

- Notice the **Parametric-Modeling** project name is displayed as the active project.

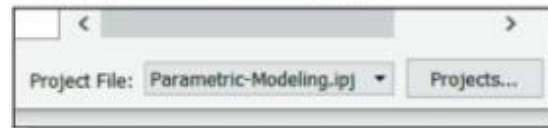

6. Select the **en-US → English** tab as shown below. When starting a new CAD file, the first thing we should do is choose the units we would like to use. We will use the English setting (inches) for this example.

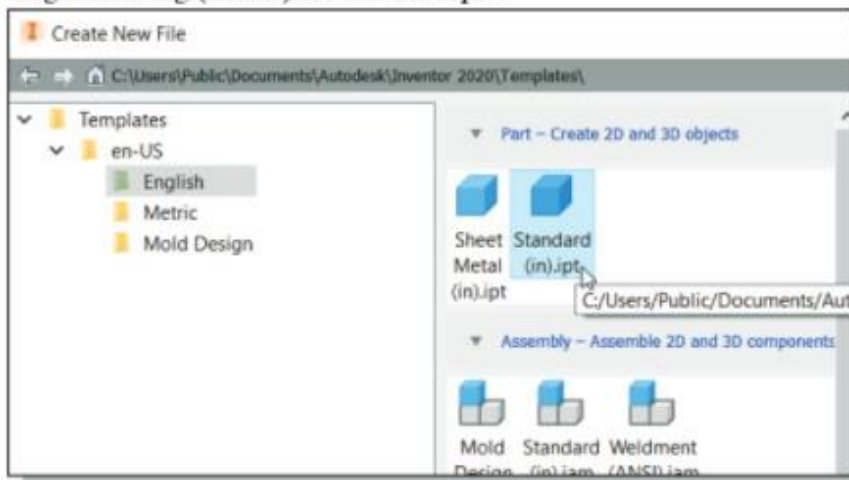

7. Select the **Standard(in).ipt** icon as shown.

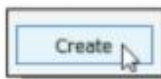

8. Pick **Create** in the *New File* dialog box to accept the selected settings.

## The Default Autodesk Inventor Screen Layout

The default Autodesk Inventor drawing screen contains the *pull-down* menus, the *Standard* toolbar, the *3D Model* toolbar, the *Sketch* toolbar, the *drawing* area, the *browser* area, and the *Status Bar*. A line of quick text appears next to the icon as you move the *mouse cursor* over different icons. You may resize the *Autodesk Inventor* drawing window by clicking and dragging the edges of the window or relocate the window by clicking and dragging the window title area.

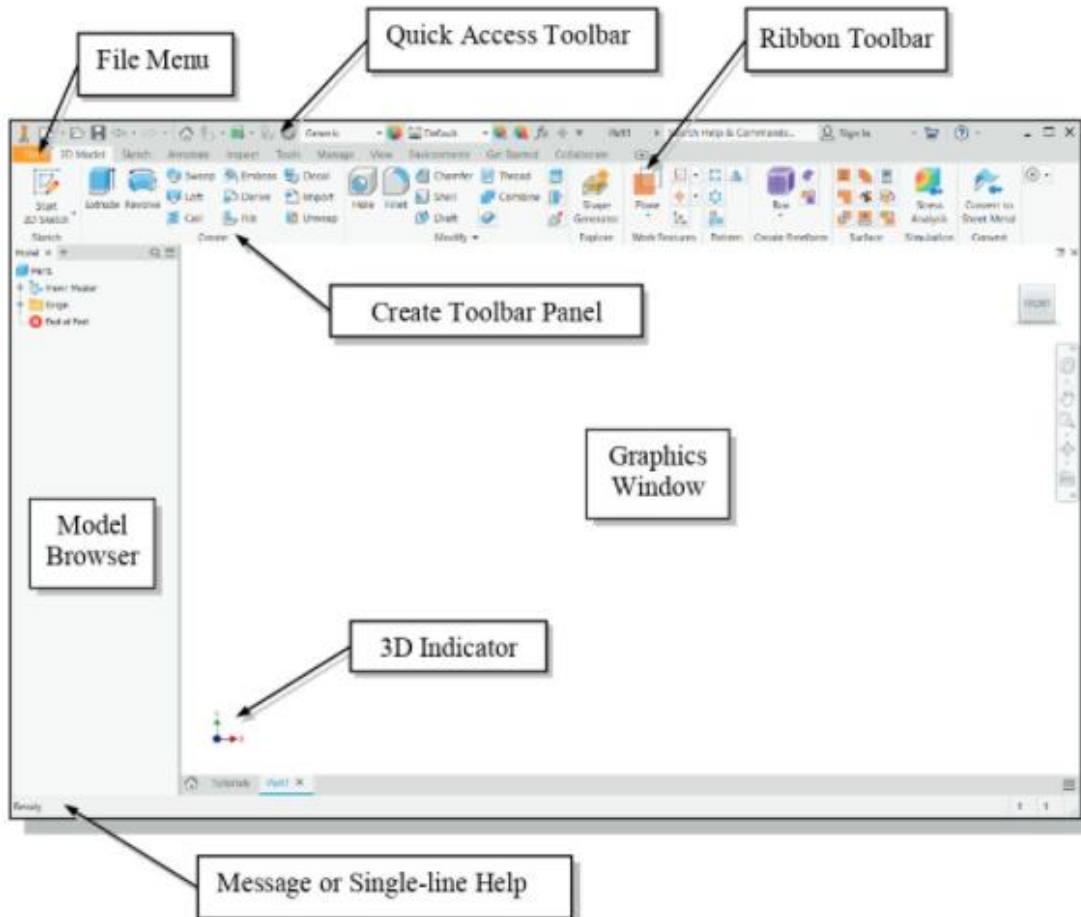

The **Ribbon Toolbar** is a relatively new feature in Autodesk Inventor; the **Ribbon Toolbar** is composed of a series of tool panels, which are organized into tabs labeled by task. The **Ribbon** provides a compact palette of all of the tools necessary to accomplish the different modeling tasks. The drop-down arrow next to any icon indicates additional commands are available on the expanded panel; access the expanded panel by clicking on the drop-down arrow.



## Sketch Plane – It is an XY monitor, but an XYZ World

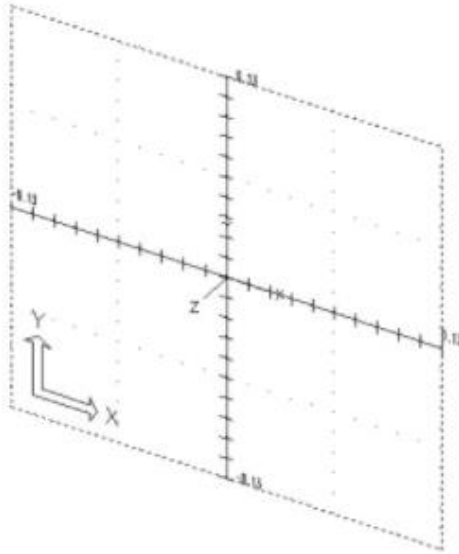

Design modeling software is becoming more powerful and user friendly, yet the system still does only what the user tells it to do. When using a geometric modeler, we therefore need to have a good understanding of what its inherent limitations are.

In most 3D geometric modelers, 3D objects are located and defined in what is usually called **world space** or **global space**. Although a number of different coordinate systems can be used to create and manipulate objects in a 3D modeling system, the objects are typically defined and stored using the world space. The world space is usually a **3D Cartesian coordinate system** that the user cannot change or manipulate.

In engineering designs, models can be very complex, and it would be tedious and confusing if only the world coordinate system were available. Practical 3D modeling systems allow the user to define **Local Coordinate Systems (LCS)** or **User Coordinate Systems (UCS)** relative to the world coordinate system. Once a local coordinate system is defined, we can then create geometry in terms of this more convenient system.

Although objects are created and stored in 3D space coordinates, most of the geometric entities can be referenced using 2D Cartesian coordinate systems. Typical input devices such as a mouse or digitizer are two-dimensional by nature; the movement of the input device is interpreted by the system in a planar sense. The same limitation is true of common output devices, such as displays and plotters. The modeling software performs a series of three-dimensional to two-dimensional transformations to correctly project 3D objects onto the 2D display plane.

The Autodesk Inventor *sketching plane* is a special construction approach that enables the planar nature of the 2D input devices to be directly mapped into the 3D coordinate system. The *sketching plane* is a local coordinate system that can be aligned to an existing face of a part, or a reference plane.

Think of the sketching plane as the surface on which we can sketch the 2D sections of the parts. It is similar to a piece of paper, a white board, or a chalkboard that can be attached to any planar surface. The first sketch we create is usually drawn on one of the established datum planes. Subsequent sketches/features can then be created on sketching planes that are aligned to existing **planar faces of the solid part** or **datum planes**.

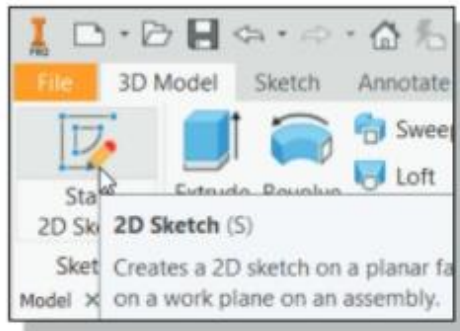

1. Activate the **Start 2D Sketch** icon with a single click of the left-mouse-button.

2. Move the cursor over the edge of the *XY Plane* in the graphics area. When the *XY Plane* is highlighted, click once with the **left-mouse-button** to select the *Plane* as the sketch plane for the new sketch.

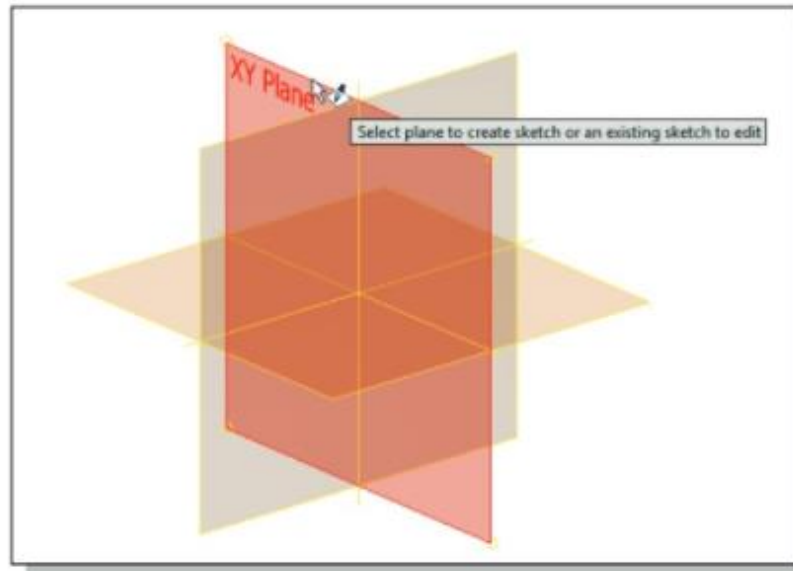

- The *sketching plane* is a reference location where two-dimensional sketches are created. Note that the *sketching plane* can be any planar part surface or datum plane.
3. Confirm the main *Ribbon* area is switched to the **Sketch** toolbars; this indicates we have entered the 2D Sketching mode.

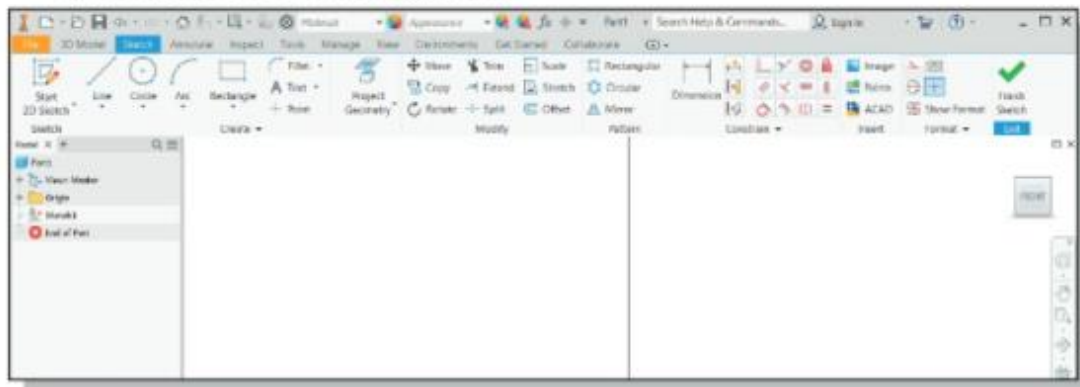

## Creating Rough Sketches

Quite often during the early design stage, the shape of a design may not have any precise dimensions. Most conventional CAD systems require the user to input the precise lengths and locations of all geometric entities defining the design, which are not available during the early design stage. With *parametric modeling*, we can use the computer to elaborate and formulate the design idea further during the initial design stage. With Autodesk Inventor, we can use the computer as an electronic sketchpad to help us concentrate on the formulation of forms and shapes for the design. This approach is the main advantage of *parametric modeling* over conventional solid-modeling techniques.

As the name implies, a *rough sketch* is not precise at all. When sketching, we simply sketch the geometry so that it closely resembles the desired shape. Precise scale or lengths are not needed. Autodesk Inventor provides many tools to assist us in finalizing sketches. For example, geometric entities such as horizontal and vertical lines are set automatically. However, if the rough sketches are poor, it will require much more work to generate the desired parametric sketches. Here are some general guidelines for creating sketches in Autodesk Inventor:

- **Create a sketch that is proportional to the desired shape.** Concentrate on the shapes and forms of the design.
  - **Keep the sketches simple.** Leave out small geometry features such as fillets, rounds and chamfers. They can easily be placed using the **Fillet** and **Chamfer** commands after the parametric sketches have been established.
  - **Exaggerate the geometric features of the desired shape.** For example, if the desired angle is 85 degrees, create an angle that is 50 or 60 degrees. Otherwise, Autodesk Inventor might assume the intended angle to be a 90-degree angle.
  - **Draw the geometry so that it does not overlap.** The geometry should eventually form a closed region. *Self-intersecting* geometry shapes are not allowed.
  - **The sketched geometric entities should form a closed region.** To create a solid feature, such as an extruded solid, a closed region is required so that the extruded solid forms a 3D volume.
- **Note:** The concepts and principles involved in *parametric modeling* are very different, and sometimes they are totally opposite, to those of conventional computer aided drafting. In order to understand and fully utilize Autodesk Inventor's functionality, it will be helpful to take a *Zen* approach to learning the topics presented in this text: **Have an open mind and temporarily forget your experiences using conventional Computer Aided Drafting systems.**

## Step 1: Creating a Rough Sketch

The *Sketch* toolbar provides tools for creating the basic geometry that can be used to create features and parts.

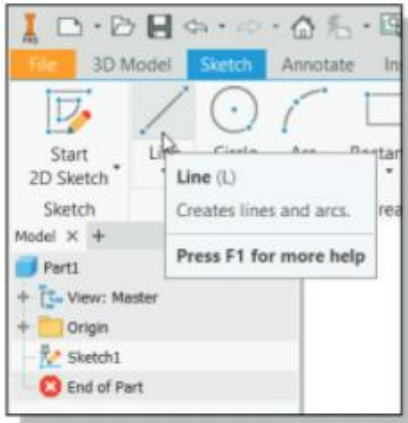

1. Move the graphics cursor to the **Line** icon in the *Sketch* toolbar. A *Help-tip box* appears next to the cursor and a brief description of the command is displayed at the bottom of the drawing screen: “Creates Straight lines and arcs.”
2. Select the icon by clicking once with the **left-mouse-button**; this will activate the **Line** command. Autodesk Inventor expects us to identify the starting location of a straight line.

## Graphics Cursors

Notice the cursor changes from an arrow to a crosshair when graphical input is expected.

1. Left-click a starting point for the shape, roughly just below and to the right of the center of the graphics window.
2. As you move the graphics cursor, you will see a digital readout next to the cursor and also in the *Status Bar* area at the bottom of the window. The readout gives you the cursor location, the line length, and the angle of the line measured from horizontal. Move the cursor around and you will notice different symbols appear at different locations.

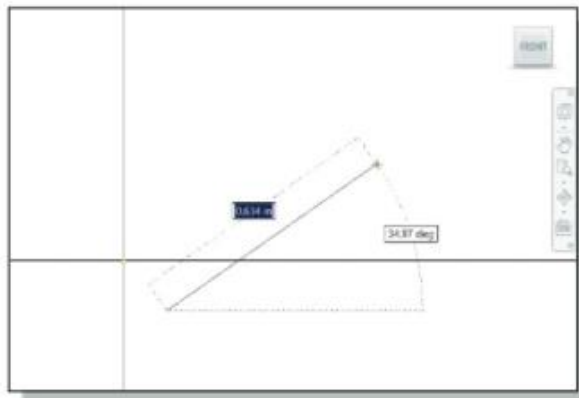

- The readout displayed next to the cursor is called the **Dynamic Input**. This option is part of the **Heads-Up Display** option that is now available in Inventor. Note that *Dynamic Input* can be used for entering precise values, but its usage is somewhat limited in *parametric modeling*.

3. Move the graphics cursor toward the right side of the graphics window and create a horizontal line as shown below (**Point 2**). Notice the geometric constraint symbol, a short horizontal line indicating the geometric property, is displayed.

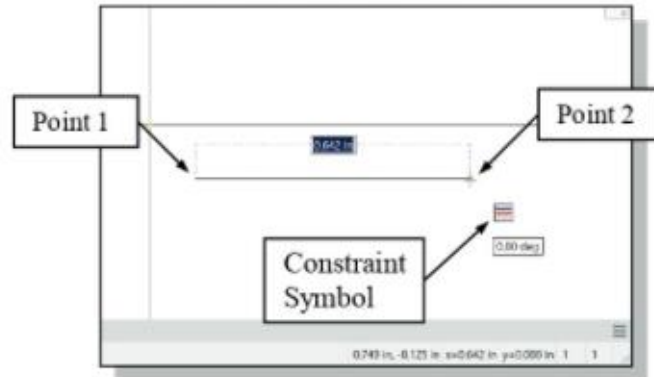

## Geometric Constraint Symbols

Autodesk Inventor displays different visual clues, or symbols, to show you alignments, perpendicularities, tangencies, etc. These constraints are used to capture the *design intent* by creating constraints where they are recognized. Autodesk Inventor displays the governing geometric rules as models are built. To prevent constraints from forming, hold down the **[Ctrl]** key while creating an individual sketch curve. For example, while sketching line segments with the **Line** command, endpoints are joined with a **Coincident constraint**, but when the **[Ctrl]** key is pressed and held, the inferred constraint will not be created.

	<b>Vertical</b>	indicates a line is vertical
	<b>Horizontal</b>	indicates a line is horizontal
	<b>Dashed line</b>	indicates the alignment is to the center point or endpoint of an entity
	<b>Parallel</b>	indicates a line is parallel to other entities
	<b>Perpendicular</b>	indicates a line is perpendicular to other entities
	<b>Coincident</b>	indicates the cursor is at the endpoint of an entity
	<b>Concentric</b>	indicates the cursor is at the center of an entity
	<b>Tangent</b>	indicates the cursor is at tangency points to curves



1. Complete the sketch as shown below, creating a closed region ending at the starting point (**Point 1**). Do not be overly concerned with the actual size of the sketch. Note that all line segments are sketched horizontally or vertically.

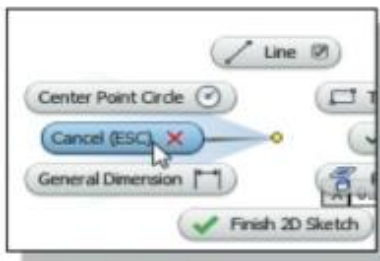
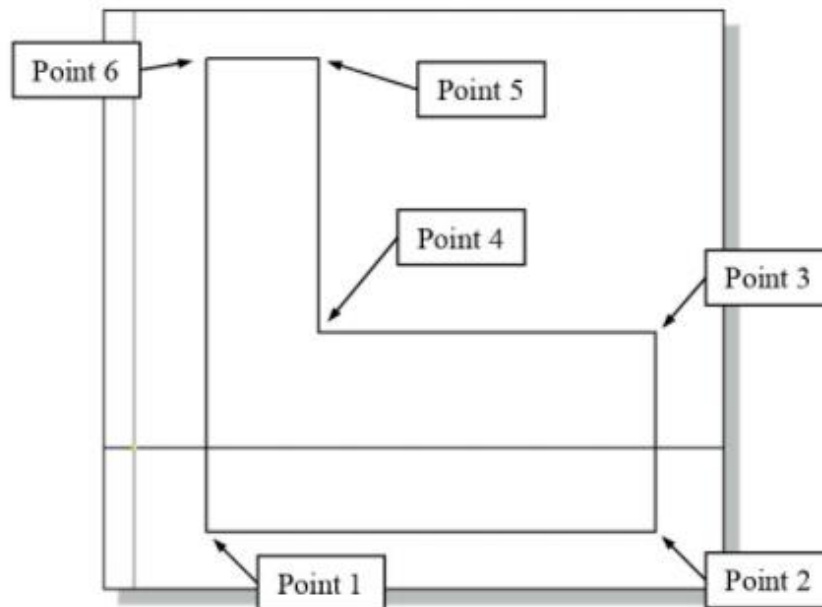

2. Inside the graphics window, click once with the **right-mouse-button** to display the option menu. Select **Cancel [Esc]** in the pop-up menu, or hit the **[Esc]** key once to end the **Sketch Line** command.

## Step 2: Apply/Modify Constraints and Dimensions

As the sketch is made, Autodesk Inventor automatically applies some of the geometric constraints (such as horizontal, parallel, and perpendicular) to the sketched geometry. We can continue to modify the geometry, apply additional constraints, and/or define the size of the existing geometry. In this example, we will illustrate adding dimensions to describe the sketched entities.

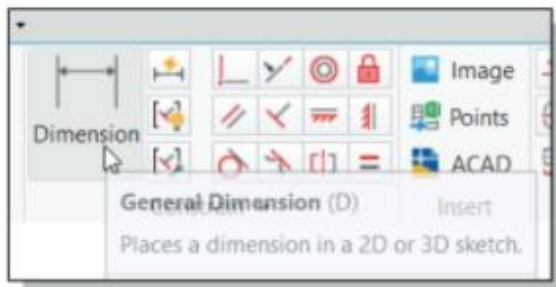

1. Move the cursor to the *Constrain* toolbar area; it is the toolbar next to the *2D Draw* toolbar. Note the first icon in this toolbar is the **General Dimension** icon. The **Dimension** command is generally known as **Smart Dimensioning** in parametric modeling.

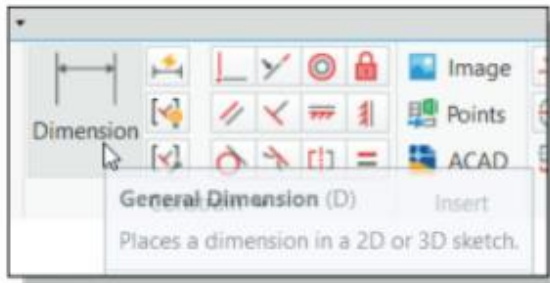

2. Move the cursor on top of the Dimension icon. The Smart Dimensioning command allows us to quickly create and modify dimensions. **Left-click** once on the icon to activate the Dimension command.

3. The message “Select Geometry to Dimension” is displayed in the Status Bar area at the bottom of the Inventor window. Select the bottom horizontal line by left-clicking once on the line.

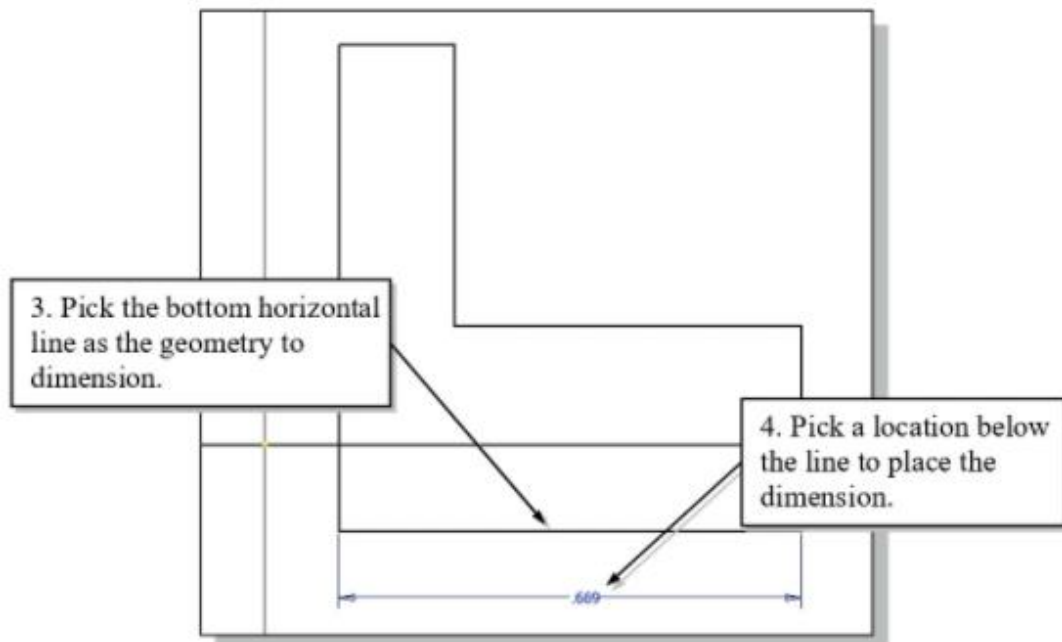

4. Move the graphics cursor below the selected line and **left-click** to place the dimension. (Note that the value displayed on your screen might be different than what is shown in the figure above.)



5. Accept the *default value* by clicking on the **Accept** button as shown.

- ❖ The General Dimension command will create a length dimension if a single line is selected.
6. The message “Select Geometry to Dimension” is displayed in the Status Bar area, located at the bottom of the Inventor window. Select the top-horizontal line as shown on the next page.

7. Select the bottom-horizontal line as shown below.

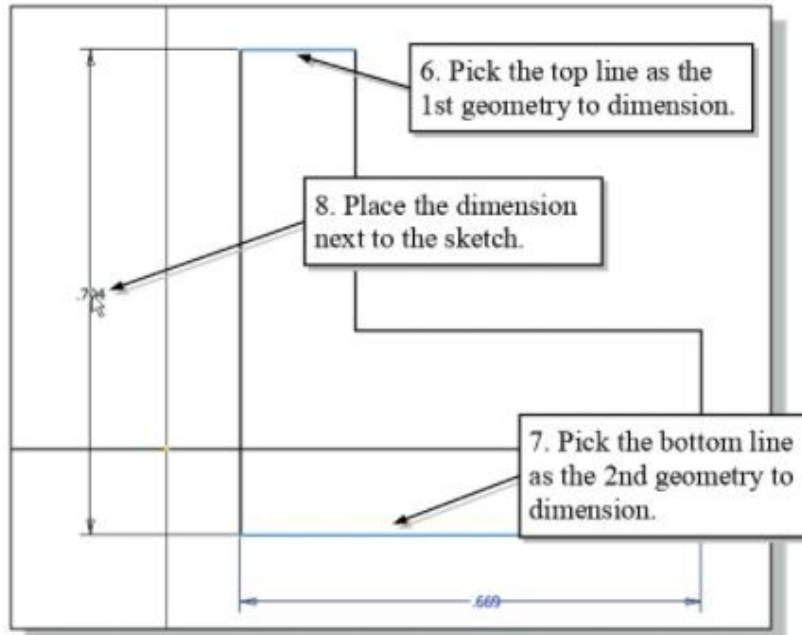

8. Pick a location to the left of the sketch to place the dimension.



9. Accept the default value by clicking on the **Accept** button.

❖ When two parallel lines are selected, the **General Dimension** command will create a dimension measuring the distance between them.

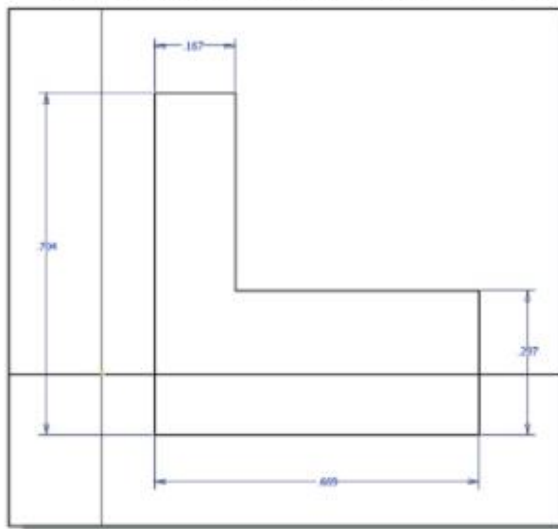

10. On your own, repeat the above steps and create additional dimensions (accepting the default values created by Inventor) so that the sketch appears as shown.

## Dynamic Viewing Functions – Zoom and Pan

Autodesk Inventor provides a special user interface called *Dynamic Viewing* that enables convenient viewing of the entities in the graphics window.



1. Click on the **Zoom** icon located in the *Navigation* bar as shown.
2. Move the cursor near the center of the graphics window.
3. Inside the graphics window, **press and hold down the left-mouse-button**, then move downward to enlarge the current display scale factor.
4. Press the **[Esc]** key once to exit the Zoom command.

5. Click on the **Pan** icon located above the Zoom command in the *Navigation* bar. The icon is the picture of a hand.

➤ The **Pan** command enables us to move the view to a different position. This function acts as if you are using a video camera.

6. On your own, use the Zoom and Pan options to reposition the sketch near the center of the screen.



## Modifying the Dimensions of the Sketch

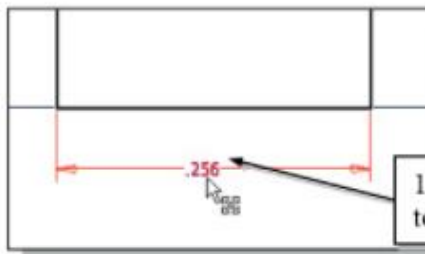

1. Select the dimension that is at the bottom of the sketch by **double-clicking** on the dimension text.

1. Select this dimension to modify.

2. In the *Edit Dimension* window, the current length of the line is displayed. Enter **2.5** to set the length of the line.
3. Click on the **Accept** icon to accept the entered value.



➤ Autodesk Inventor will now update the profile with the new dimension value.

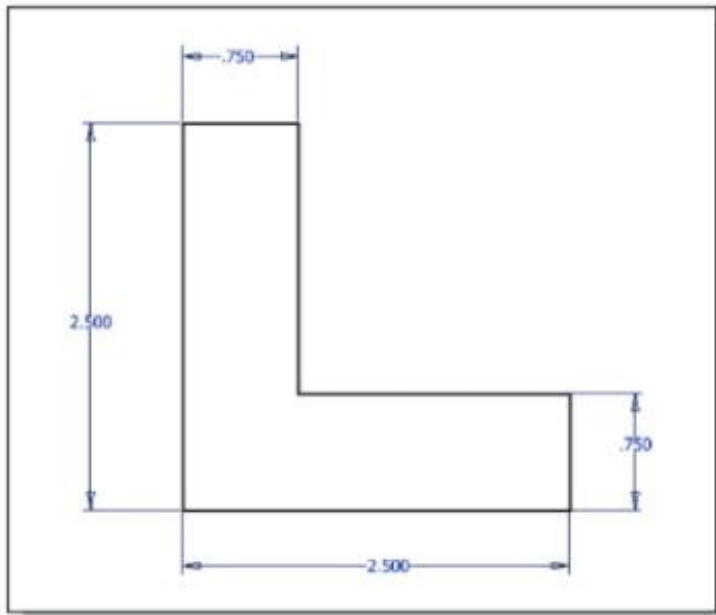

4. On your own, repeat the above steps and adjust the dimensions so that the sketch appears as shown.



5. In the *Ribbon* toolbar, click once with the **left-mouse-button** to select **Finish Sketch** in the *Ribbon* area to end the **Sketch** option.

### Step 3: Completing the Base Solid Feature

Now that the 2D sketch is completed, we will proceed to the next step: create a 3D part from the 2D profile. Extruding a 2D profile is one of the common methods that can be used to create 3D parts. We can extrude planar faces along a path. We can also specify a height value and a tapered angle. In Autodesk Inventor, each face has a positive side and a negative side; the current face we are working on is set as the default positive side. This positive side identifies the positive extrusion direction and it is referred to as the face's *normal*.

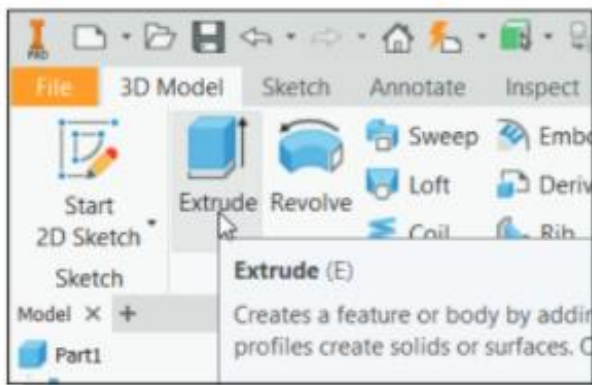

1. In the 3D Model tab, select the **Extrude** command by clicking the left-mouse-button on the icon as shown.



- In the *Extrude* edit box, enter **2.5** as the extrusion distance. Notice that the sketch region is automatically selected as the extrusion profile.

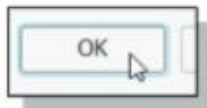
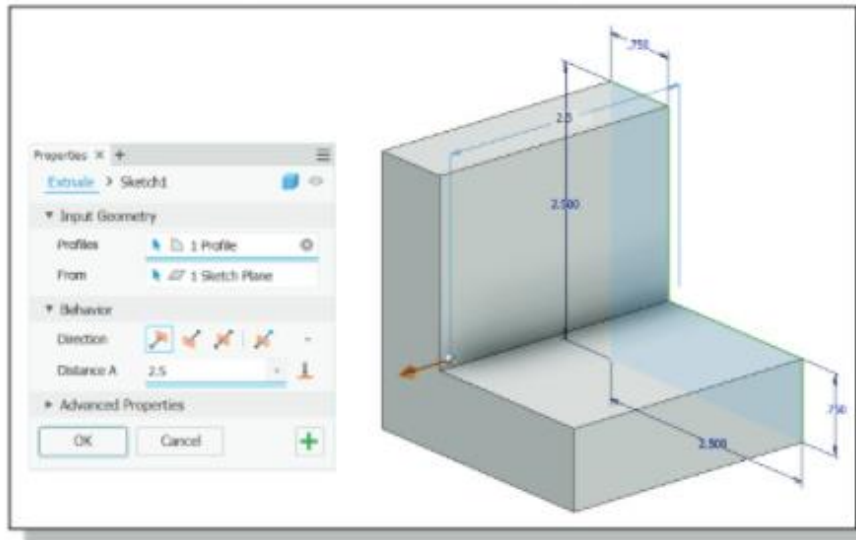

- Click on the **OK** button to proceed with creating the 3D part.

- Note that all dimensions disappeared from the screen. All parametric definitions are stored in the **Autodesk Inventor database** and any of the parametric definitions can be re-displayed and edited at any time.

## Isometric View

Autodesk Inventor provides many ways to display views of the three-dimensional design. Several options are available that allow us to quickly view the design to track the overall effect of any changes being made to the model. We will first orient the model to display in the *isometric view* by using the pull-down menu.

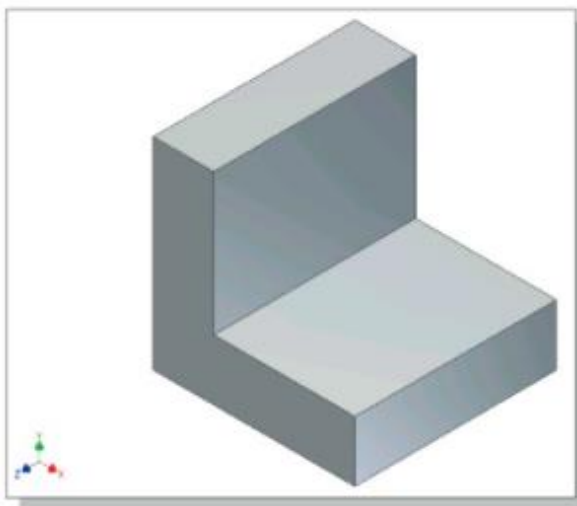

- Hit the function key **[F6]** once to automatically adjust the display and also reset the display to the *isometric view*.
- Note that most of the view-related commands can be accessed in the **ViewCube** and/or the *Navigation* bar located to the right side of the graphics window.

### ❖ Dynamic Rotation of the 3D Block – Free Orbit

The **Free Orbit** command allows us to:

- Orbit a part or assembly in the graphics window. Rotation can be around the center mark, free in all directions, or around the X/Y-axes in the *3D-Orbit* display.
- Reposition the part or assembly in the graphics window.
- Display isometric or standard orthographic views of a part or assembly.

The **Free Orbit** tool is accessible while other tools are active. Autodesk Inventor remembers the last used mode when you exit the **Orbit** command.



1. Click on the **Free Orbit** icon in the *Navigation* bar.

- The *3D Orbit* display is a circular rim with four handles and a center mark. *3D Orbit* enables us to manipulate the view of 3D objects by clicking and dragging with the left-mouse-button:

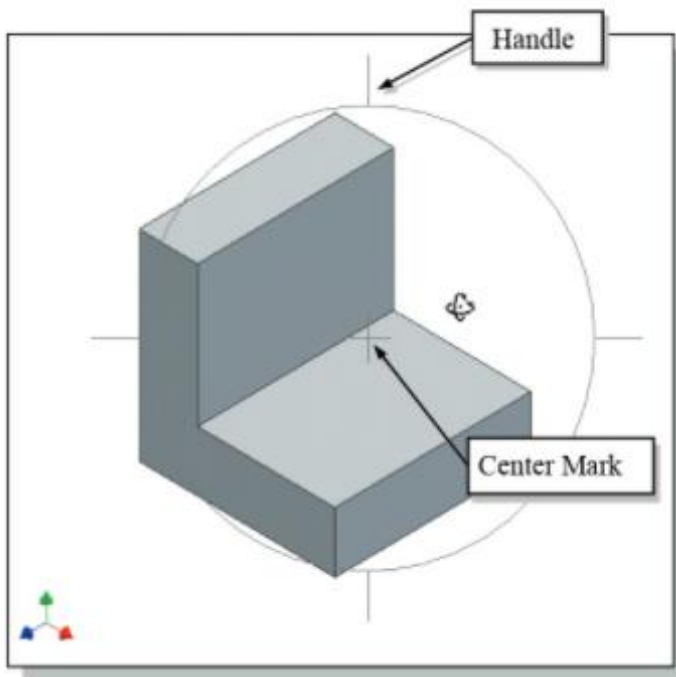

- Drag with the left-mouse-button near the center for free rotation.
- Drag on the handles to orbit around the horizontal or vertical axes.
- Drag on the rim to orbit about an axis that is perpendicular to the displayed view.
- Single left-click to align the center mark of the view.

2. Inside the *circular rim*, press down the left-mouse-button and drag in an arbitrary direction; the *3D Orbit* command allows us to freely orbit the solid model.
3. Move the cursor near the circular rim and notice the cursor symbol changes to a single circle. Drag with the left-mouse-button to orbit about an axis that is perpendicular to the displayed view.

4. Single left-click near the top-handle to align the selected location to the center mark in the graphics window.
  5. Activate the **Constrained Orbit** option by clicking on the associated icon as shown.
- ❖ *The Constrained Orbit can be used to rotate the model about axes in Model Space, equivalent to moving the eye position about the model in latitude and longitude.*

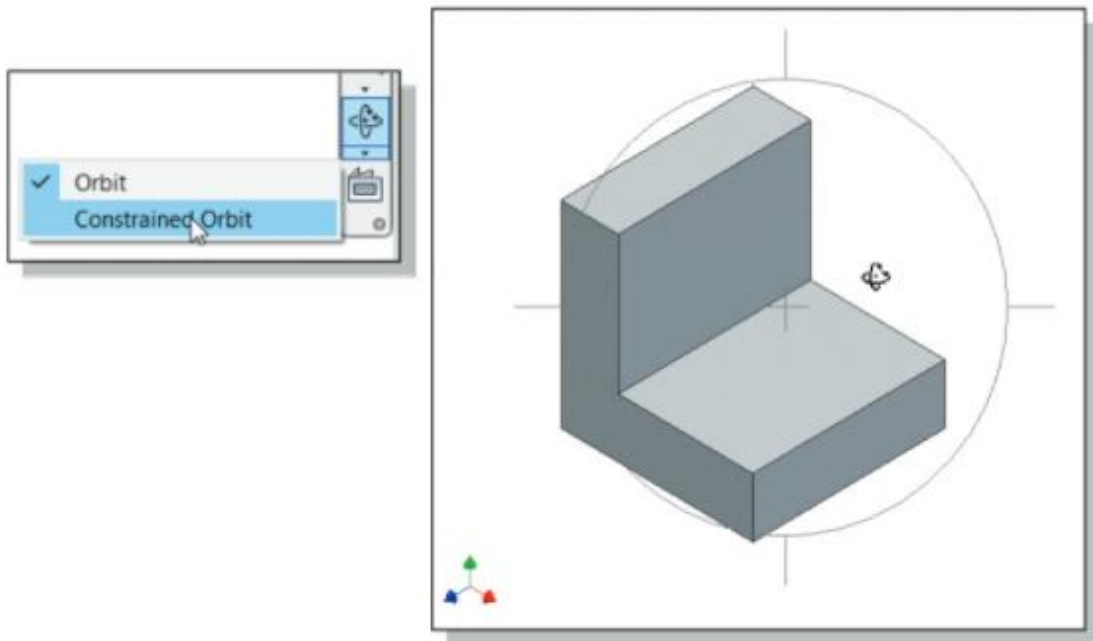

6. On your own, use the different options described in the above steps and familiarize yourself with both of the 3D Orbit commands. Reset the display to the *Isometric* view as shown in the above figure before continuing to the next section.
- ❖ Note that while in the 3D Orbit mode, a horizontal marker will be displayed next to the cursor if the cursor is away from the circular rim. This is the **exit marker**. Left-clicking once will allow you to exit the 3D Orbit command.

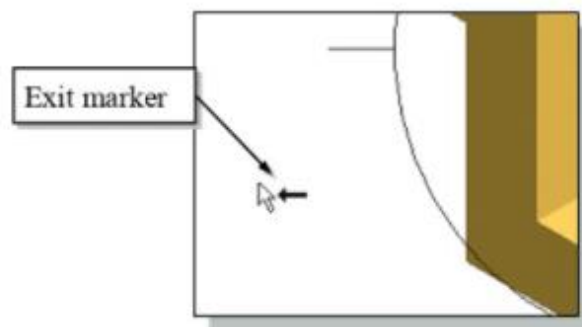

## Dynamic Viewing – Quick Keys

We can also use the function keys on the keyboard and the mouse to access the *Dynamic Viewing* functions.

### ❖ Panning – (1) F2 and the left-mouse-button

Hold the **F2** function key down and drag with the left-mouse-button to pan the display. This allows you to reposition the display while maintaining the same scale factor of the display.

#### Pan

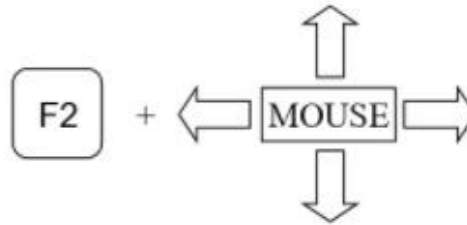

### (2) Press and drag with the mouse wheel

Pressing and dragging with the mouse wheel can also reposition the display.

### ❖ Zooming – (1) F3 and drag with the left-mouse-button

Hold the **F3** function key down and drag with the left-mouse-button vertically on the screen to adjust the scale of the display. Moving upward will reduce the scale of the display, making the entities display smaller on the screen. Moving downward will magnify the scale of the display.

#### Zoom

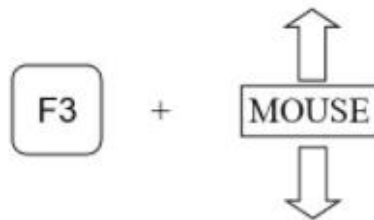

### (2) Turning the mouse wheel

Turning the mouse wheel can also adjust the scale of the display. Turning forward will reduce the scale of the display, making the entities display smaller on the screen. Turning backward will magnify the scale of the display.

❖ **3D Dynamic Rotation – Shift and the middle-mouse-button**

Hold the **Shift** key down and drag with the middle-mouse-button to orbit the display. Note that the 3D dynamic rotation can also be activated using the **F4** function key and the left-mouse-button.



**Viewing Tools – Standard Toolbar**

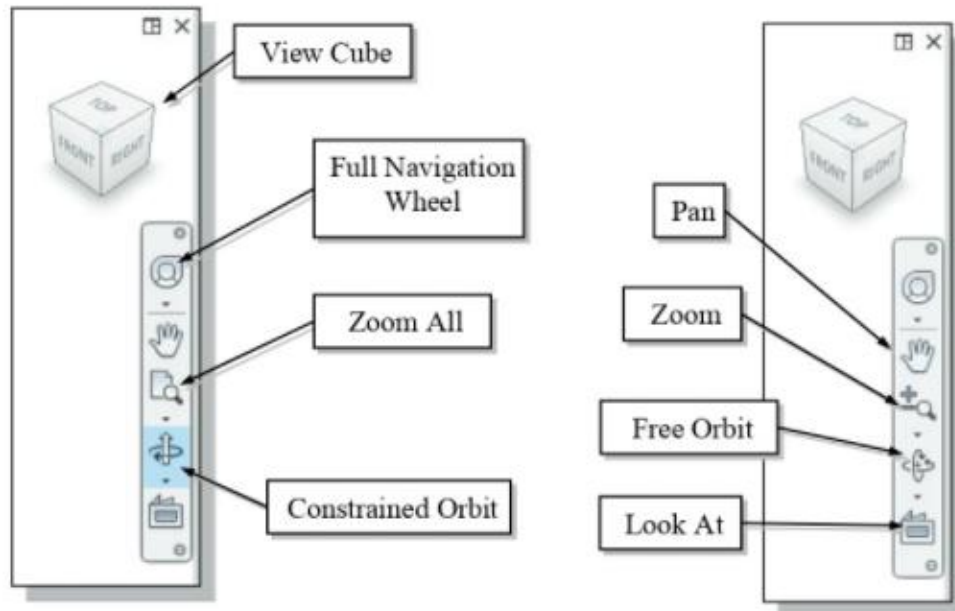

**Zoom All** – Adjusts the view so that all items on the screen fit inside the graphics window.

**Zoom Window** – Use the cursor to define a region for the view; the defined region is zoomed to fill the graphics window.

**Zoom** – Moving upward will reduce the scale of the display, making the entities display smaller on the screen. Moving downward will magnify the scale of the display.

**Pan** – This allows you to reposition the display while maintaining the same scale factor of the display.

**Zoom Selected** – In a part or assembly, zooms the selected edge, feature, line, or other element to fill the graphics window. You can select the element either before or after clicking the **Zoom** button. (Not used in drawings.)



**Orbit** – In a part or assembly, adds an orbit symbol and cursor to the view. You can orbit the view planar to the screen around the center mark, around a horizontal or vertical axis, or around the X and Y axes. (Not used in drawings.)

**Look At** – In a part or assembly, zooms and orbits the model to display the selected element planar to the screen or a selected edge or line horizontal to the screen. (Not used in drawings.)

**View Cube** – The ViewCube is a 3D navigation tool that appears, by default, when you enter Inventor. The ViewCube is a clickable interface which allows you to switch between standard and isometric views.

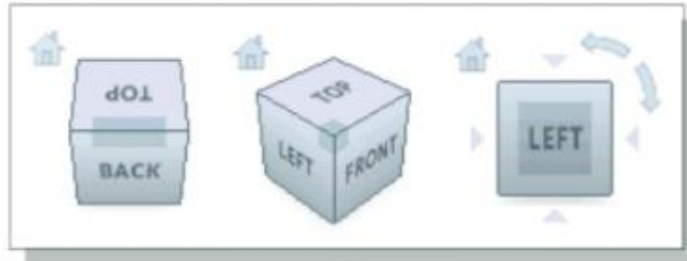

Once the ViewCube is displayed, it is shown in one of the corners of the graphics window over the model in an inactive state. The ViewCube also provides visual feedback about the current viewpoint of the model as view changes occur. When the cursor is positioned over the ViewCube, it becomes active and allows you to switch to one of the available preset views, roll the current view, or change to the Home view of the model.



1. Move the cursor over the ViewCube and notice the different sides of the ViewCube become highlighted and can be activated.
2. Single left-click when the front side is activated as shown. The current view is set to view the front side.



3. Move the cursor over the counter-clockwise arrow of the ViewCube and notice the orbit option becomes highlighted.
4. Single left-click to activate the counterclockwise option as shown. The current view is orbited 90 degrees; we are still viewing the front side.



5. Move the cursor over the left arrow of the ViewCube and notice the orbit option becomes highlighted.
6. Single left-click to activate the left arrow option as shown. The current view is now set to view the top side.



7. Move the cursor over the top edge of the **ViewCube** and notice the roll option becomes highlighted.

8. Single left-click to activate the roll option as shown. The view will be adjusted to roll 45 degrees.



9. Move the cursor over the **ViewCube** and drag with the left-mouse-button to activate the **Free Rotation** option.



10. Move the cursor over the home icon of the **ViewCube** and notice the **Home View** option becomes highlighted.

11. Single left-click to activate the **Home View** option as shown. The view will be adjusted back to the default *isometric view*.

**Full Navigation Wheel** – The **Navigation Wheel** contains tracking menus that are divided into different sections known as wedges. Each wedge on a wheel represents a single navigation tool. You can pan, zoom, or manipulate the current view of a model in different ways. The **3D Navigation Wheel** and **2D Navigation Wheel** (mostly used in the 2D drawing mode) have some or all of the following options:

- Zoom** – Adjusts the magnification of the view.
- Center** – Centers the view based on the position of the cursor over the wheel.
- Rewind** – Restores the previous view.
- Forward** – Increases the magnification of the view.
- Orbit** – Allows 3D free rotation with the left-mouse-button.
- Pan** – Allows panning by dragging with the left-mouse-button.
- Up/Down** – Allows panning with the use of a scroll control.
- Walk** – Allows *walking*, with linear motion perpendicular to the screen, through the model space.
- Look** – Allows rotation of the current view vertically and horizontally.

3D Full Navigation Wheel



2D Full Navigation Wheel





1. Activate the Full Navigation Wheel by clicking on the icon as shown.

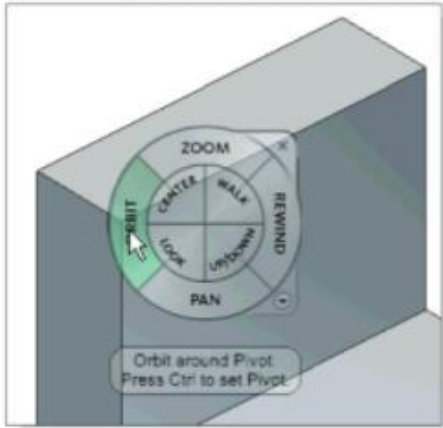

2. Move the cursor in the graphics window and notice the Full Navigation Wheel menu follows the cursor on the screen.
3. Move the cursor on the Orbit option to highlight the option.
4. Click and drag with the left-mouse-button to activate the **Free Rotation** option.

5. Drag with the left-mouse-button and notice the ViewCube also reflects the model orientation.

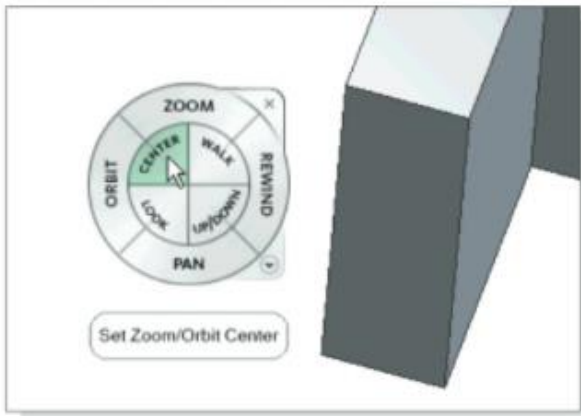
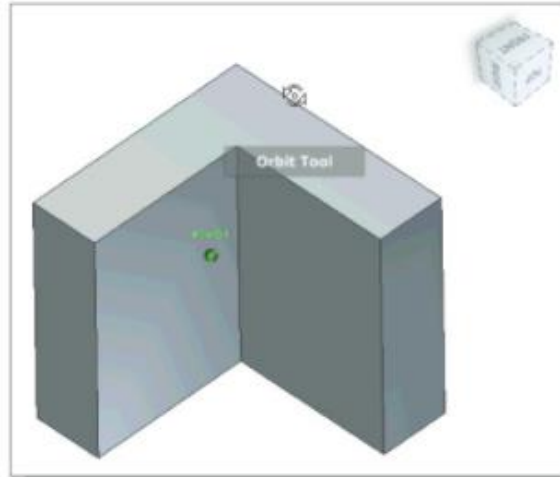

6. Move the cursor to the left side of the model and click the **Center** option as shown. The display is adjusted so the selected point is the new Zoom/Orbit center.
7. On your own, experiment with the other available options.

## Display Modes

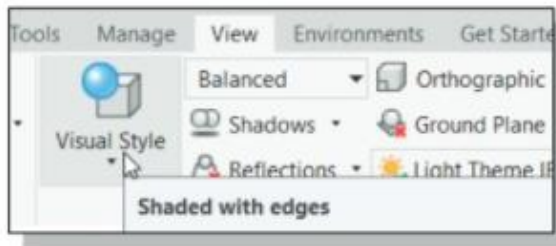

- The **Visual Style** in the *View* tab has eleven display-modes ranging from very realistic renderings of the model to very artistic representations of the model. The more commonly used modes are as follows:

### ❖ Realistic Shaded Solid:

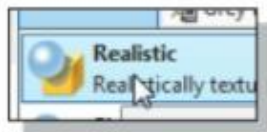

The *Realistic Shaded Solid* display mode generates a high quality shaded image of the 3D object.

### ❖ Standard Shaded Solid:

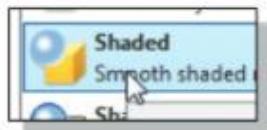

The *Standard Shaded Solid* display option generates a shaded image of the 3D object that requires fewer computer resources compared to the realistic rendering.

### ❖ Wireframe Image:

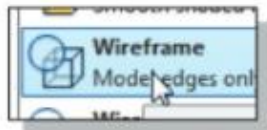

The *Wireframe Image* display option allows the display of the 3D objects using the basic wireframe representation scheme.

### ❖ Wireframe with Hidden-Edges:



The *Wireframe with Hidden-Edges* option can be used to generate an image of the 3D object with all the back lines shown as hidden-lines.

## Orthographic vs. Perspective

Besides the above basic display modes, we can also choose orthographic view or perspective view of the display. Click on the triangle icon next to the *display mode button* on the *View* toolbar.

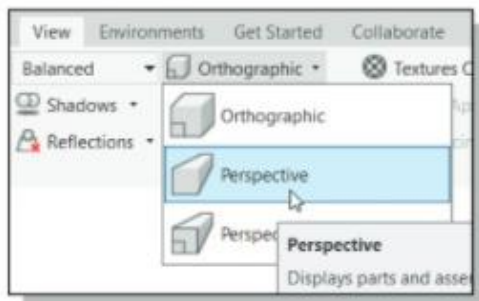

### ❖ Orthographic

The first icon allows the display of the 3D object using the parallel edges representation scheme.

### ❖ Perspective

The second icon allows the display of the 3D object using the perspective, nonparallel edges, and representation scheme.



## Disable the Heads-Up Display Option

The **Heads-Up Display** option in Inventor provides mainly the **Dynamic Input** function, which can be quite useful for 2D drafting activities. For example, in the use of a 2D drafting CAD system, most of the dimensions of the design would have been determined by the documentation stage. However, in *parametric modeling*, the usage of the *Dynamic Input* option is quite limited, as this approach does not conform to the “**shape before size**” design philosophy.

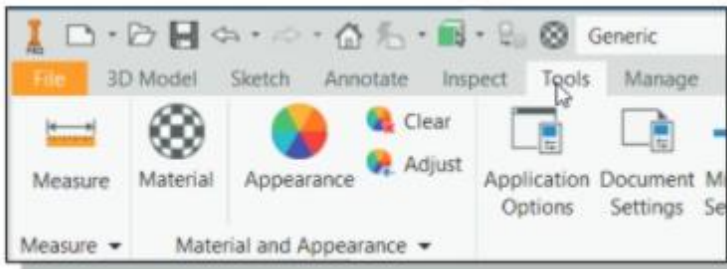

1. Select the **Tools** tab in the *Ribbon* as shown.

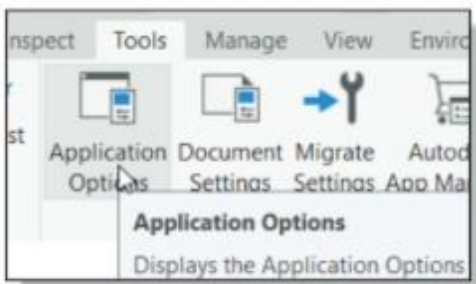

2. Select **Application Options** in the options toolbar as shown.

3. Select the **Sketch** tab to display the sketch related settings.

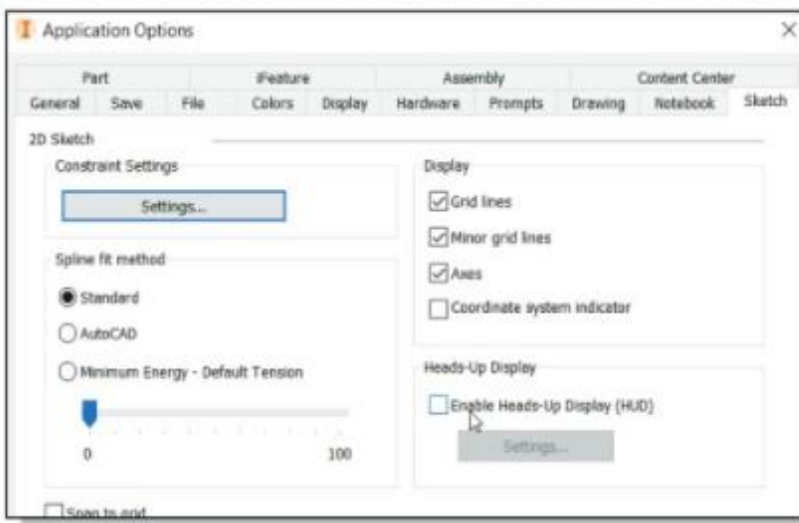

4. In the *Heads-Up Display* section, turn **OFF** the **Enable Heads-Up Display** option and switch **On** the **Grid lines**, **Minor grid lines** and **Axes** options in the *Display* section as shown.

5. On your own, examine the other sketch settings that are available.

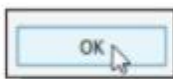

6. Click **OK** to accept the settings.



### Step 4-1: Adding an Extruded Feature

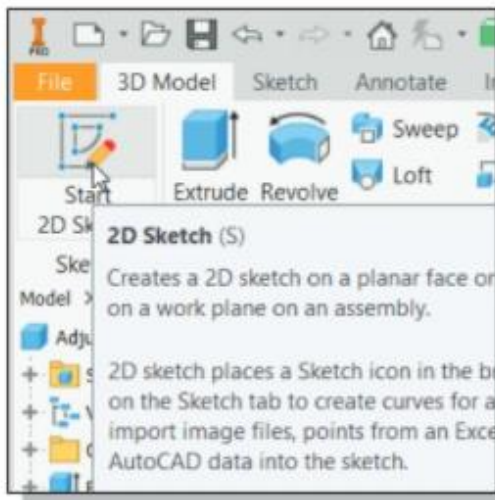

1. Activate the *3D Model* tab and select the **Start 2D Sketch** command by left-clicking once on the icon.
2. In the *Status Bar* area, the message “*Select plane to create sketch or an existing sketch to edit*” is displayed. Autodesk Inventor expects us to identify a planar surface where the 2D sketch of the next feature is to be created. Notice that Autodesk Inventor will automatically highlight feasible planes and surfaces as the cursor is on top of the different surfaces. Pick the top horizontal face of the 3D solid object.

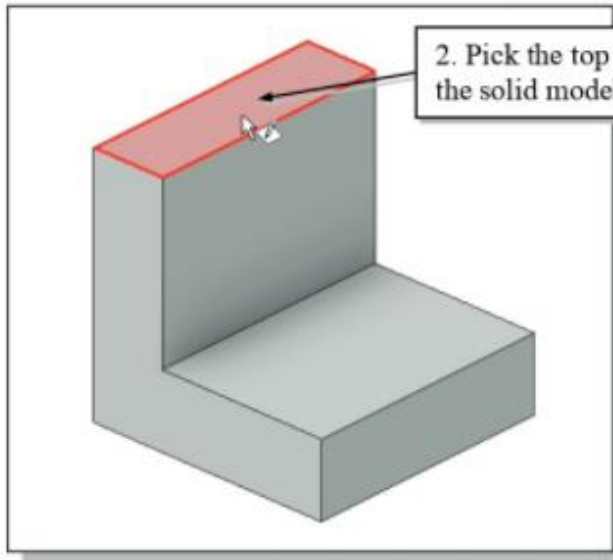

- Note that the sketch plane is aligned to the selected face. Autodesk Inventor automatically establishes a User-Coordinate-System (UCS) and records its location with respect to the part on which it was created.

- Next, we will create and profile another sketch, a rectangle, which will be used to create another extrusion feature that will be added to the existing solid object.

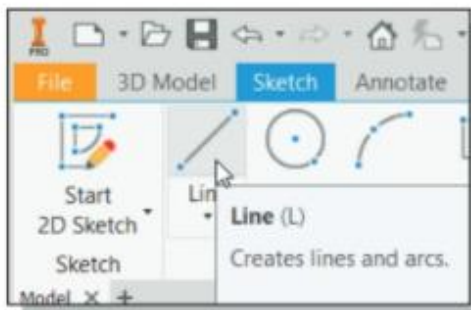

3. Select the **Line** command by clicking once with the **left-mouse-button** on the icon in the *Sketch* tab on the Ribbon.

4. Create a sketch with segments perpendicular/parallel to the existing edges of the solid model as shown below.

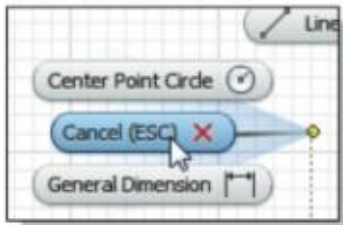
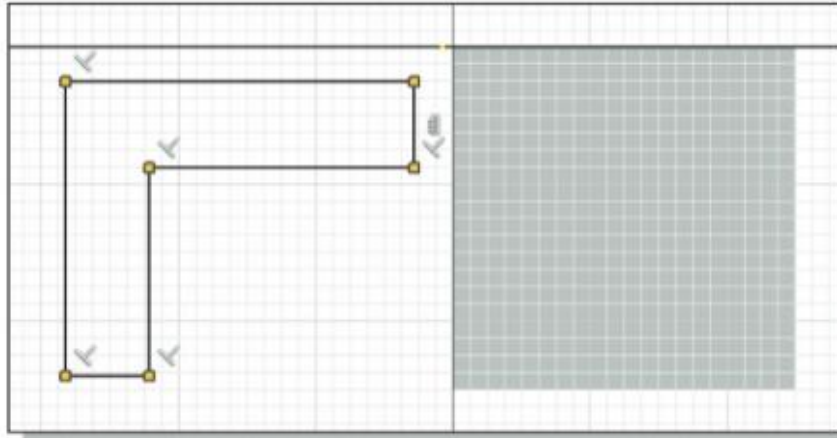

5. Inside the graphics window, click once with the **right-mouse-button** to display the option menu. Select **Cancel (ESC)** in the pop-up menu to end the Line command.

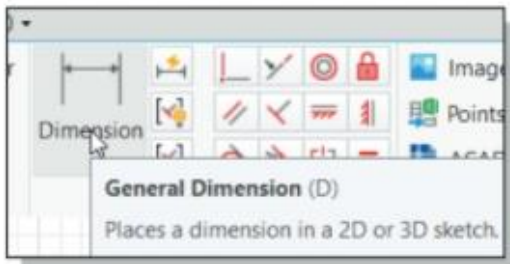

6. Select the **General Dimension** command in the *Sketch* toolbar. The **General Dimension** command allows us to quickly create and modify dimensions. Left-click once on the icon to activate the **General Dimension** command.

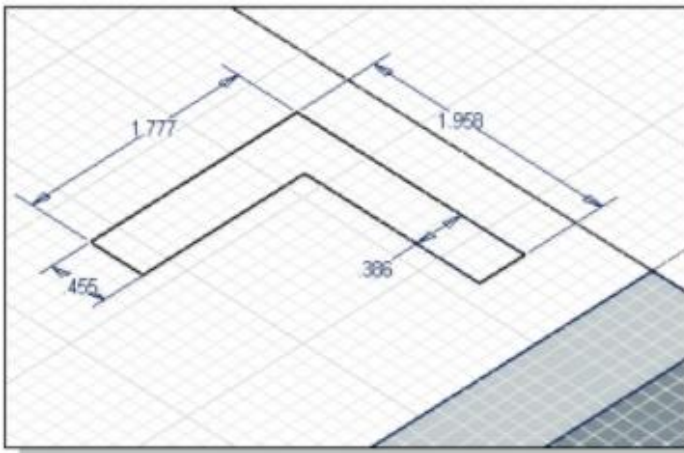

7. Hit the function key [**F6**] once to switch the display to the isometric display as shown.
8. Create the **four dimensions** to describe the size of the sketch as shown in the figure.

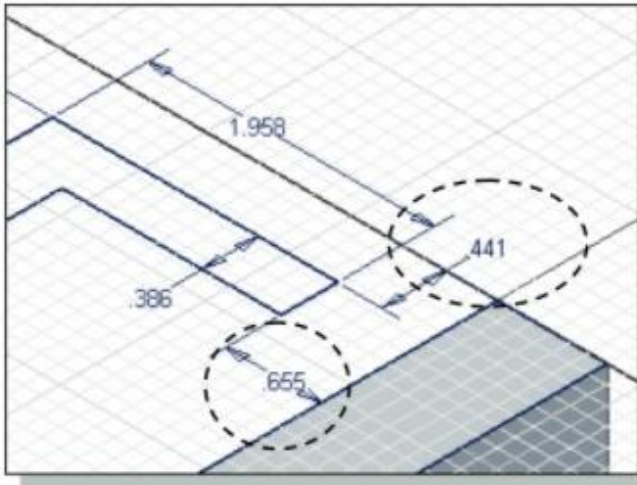

9. Create the two location dimensions to describe the position of the sketch relative to the top corner of the solid model as shown.

10. On your own, modify the two location dimensions to **0.0** and adjust the size dimensions as shown in the figure below.

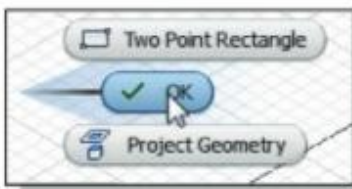
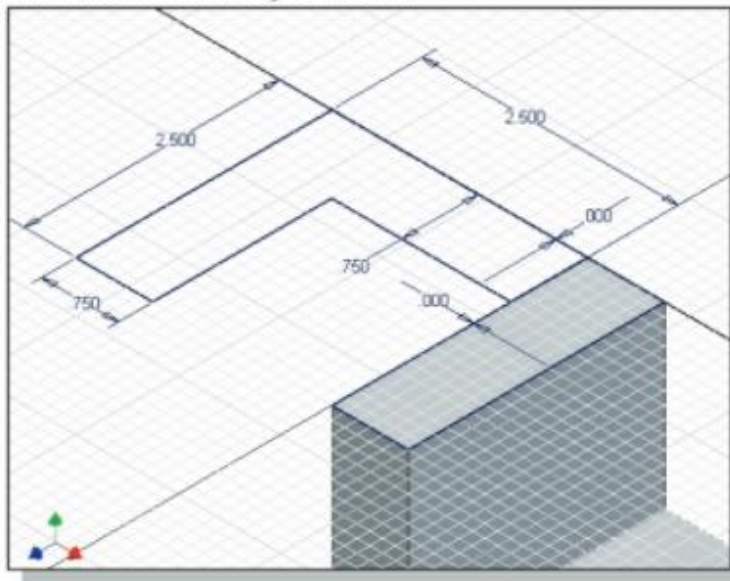

11. Inside the graphics window, click once with the **right-mouse-button** to display the option menu. Select **OK** in the pop-up menu to end the **General Dimension** command.



12. Inside the graphics window, click once with the **right-mouse-button** to display the option menu. Select **Finish 2D Sketch** in the pop-up menu to end the Sketch option.

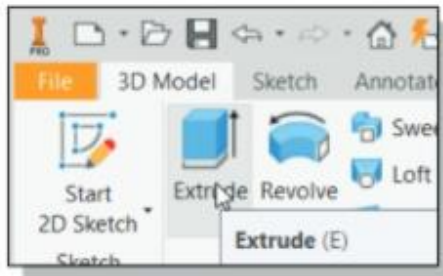

13. In the *3D Model* tab select the **Extrude** command by left-clicking on the icon.

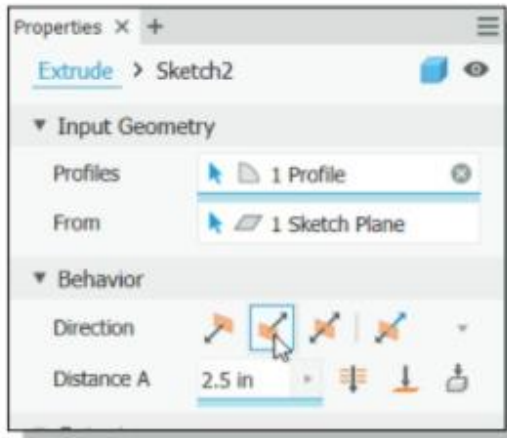

14. In the *Extrude* dialog box, enter **2.5** as the extrude distance as shown.

15. Click on the **Flipped** icon to reverse the *Extrusion Direction* as shown.

16. Confirm the *Boolean* option is set to **Join** and click on the **OK** button to proceed with creating the extruded feature.

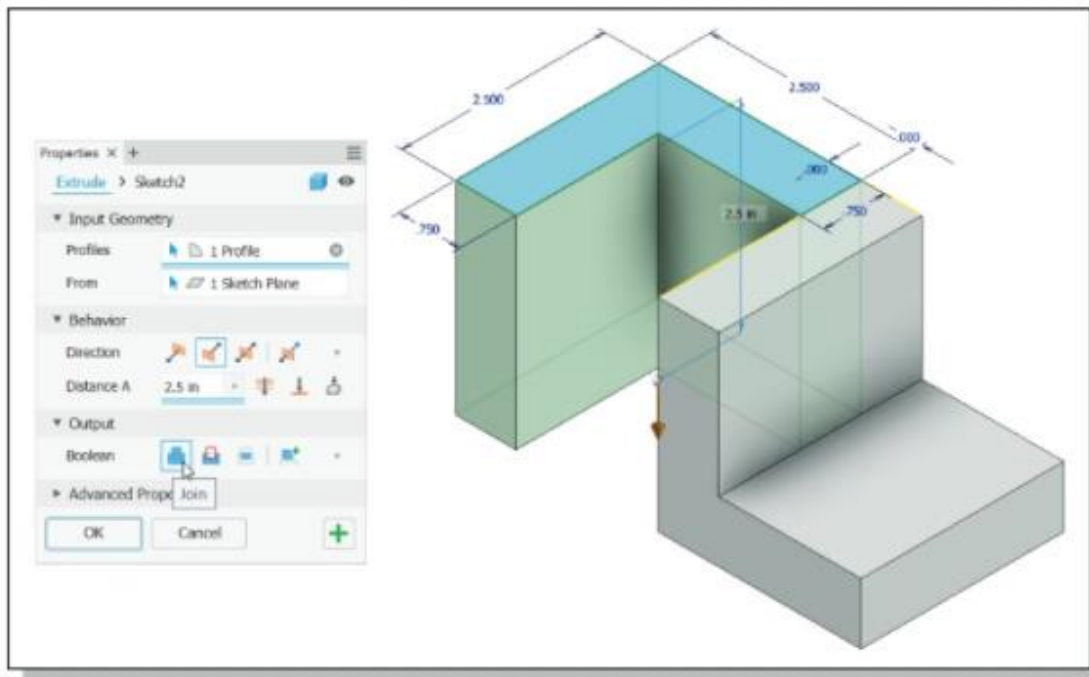



## Step 4-2: Adding a Cut Feature

Next, we will create and profile a circle, which will be used to create a cut feature that will be added to the existing solid object.

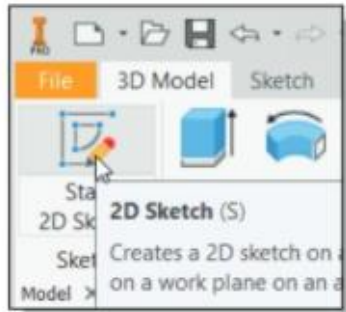

1. In the *3D Model* tab select the **Start 2D Sketch** command by left-clicking once on the icon.
2. In the *Status Bar* area, the message “*Select plane to create sketch or an existing sketch to edit.*” is displayed. Autodesk Inventor expects us to identify a planar surface where the 2D sketch of the next feature is to be created. Pick the top horizontal face of the 3D solid model as shown.

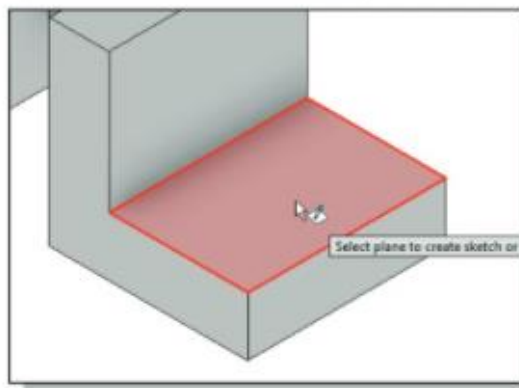

- Note that the sketch plane is aligned to the selected face. Autodesk Inventor automatically establishes a User-Coordinate-System (UCS) and records its location with respect to the part on which it was created.

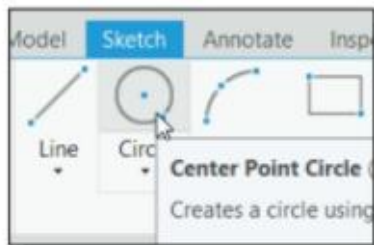

3. Select the **Center point circle** command by clicking once with the **left-mouse-button** on the icon in the *Sketch* tab on the Ribbon.

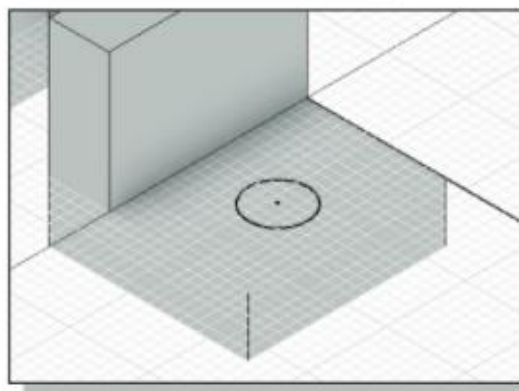

4. Create a circle of arbitrary size on the top face of the solid model as shown.



5. On your own, create and modify the dimensions of the sketch as shown in the figure.

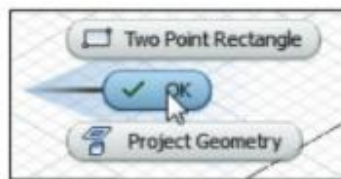
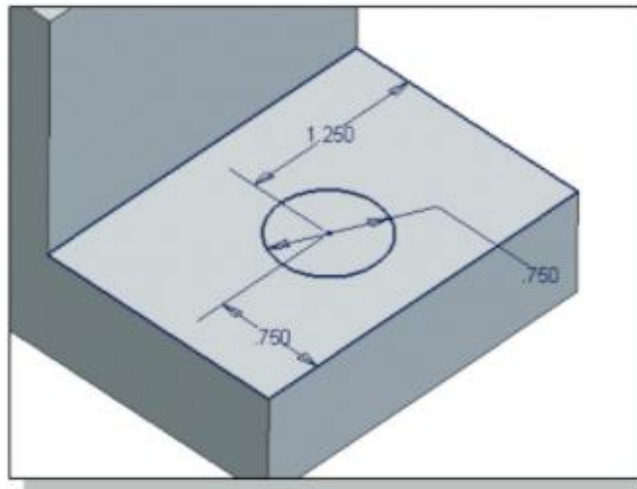

6. Inside the graphics window, click once with the **right-mouse-button** to display the option menu. Select **OK** in the pop-up menu to end the **General Dimension** command.



7. Inside the graphics window, click once with the **right-mouse-button** to display the option menu. Select **Finish 2D Sketch** in the pop-up menu to end the **Sketch** option.

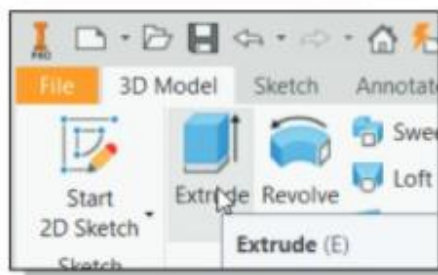

8. In the **3D Model** tab select the **Extrude** command by clicking the left-mouse-button on the icon.

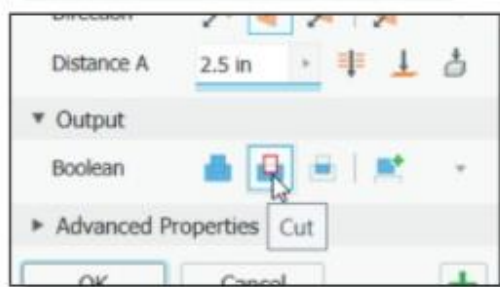

9. Select the **CUT** option in the *Output - Boolean option* list to set the extrusion operation to **Cut**.

10. Set the *Extents* option to **Through All** as shown. The *All* option instructs the software to calculate the extrusion distance and assures the created feature will always cut through the full length of the model.

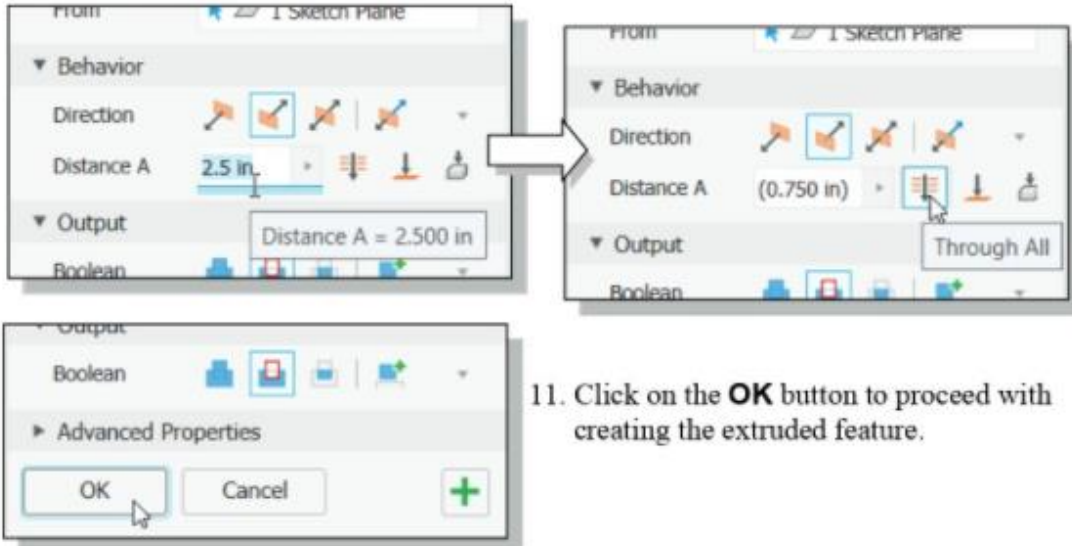

11. Click on the **OK** button to proceed with creating the extruded feature.

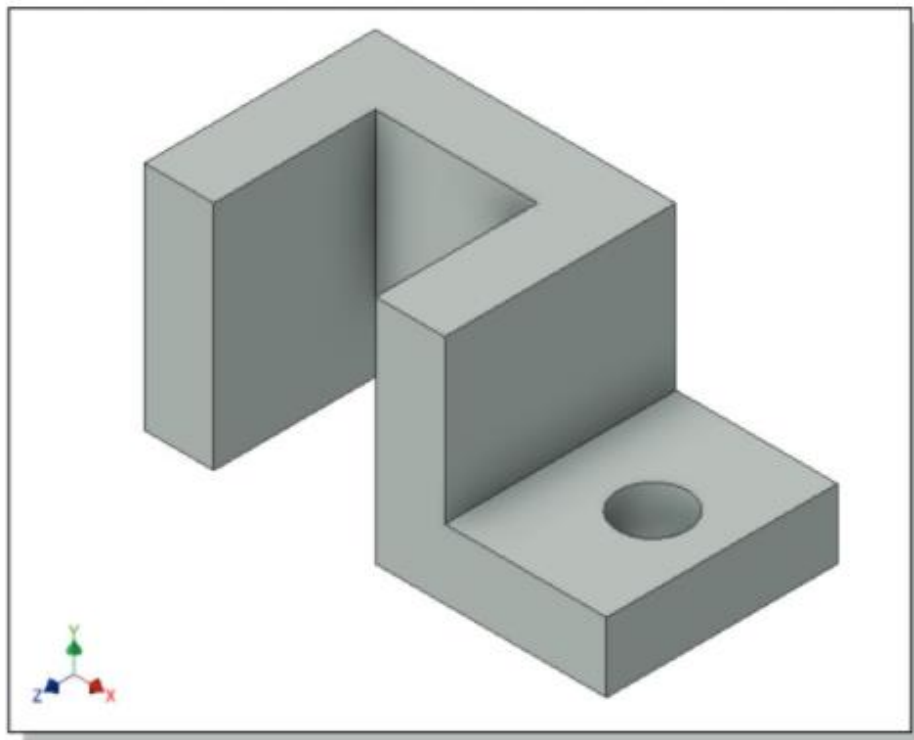

- In *Autodesk Inventor*, the **Extrude** command can be used to create solid features by either adding or subtracting extruded features.

### Step 4-3: Adding another Cut Feature

Next, we will create and profile a triangle, which will be used to create a cut feature that will be added to the existing solid object.

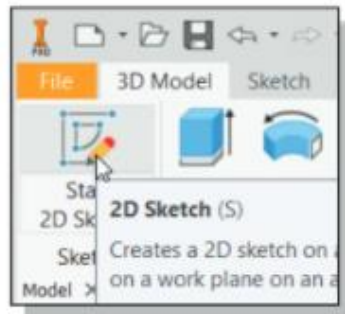

1. In the *3D Model* tab select the **Start 2D Sketch** command by left-clicking once on the icon.

2. In the *Status Bar* area, the message “*Select plane to create sketch or an existing sketch to edit.*” is displayed. Autodesk Inventor expects us to identify a planar surface where the 2D sketch of the next feature is to be created. Pick the vertical face of the 3D solid model next to the horizontal section as shown.

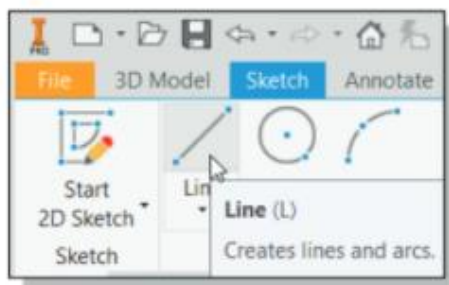
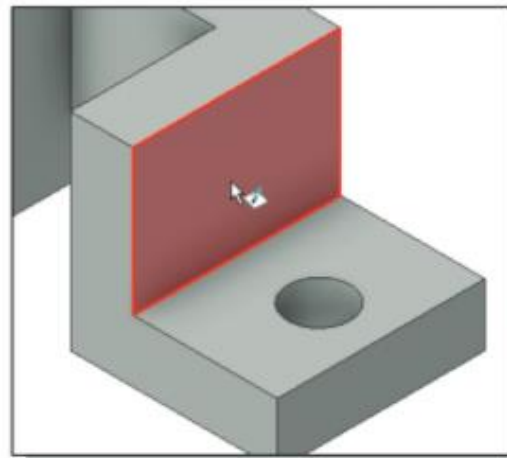

3. Select the **Line** command by clicking once with the **left-mouse-button** on the icon in the *Sketch* ribbon.

4. Start at the upper left corner and create **three line segments** to form a triangle as shown. (Do not align the endpoints to the midpoint of the existing edges.)

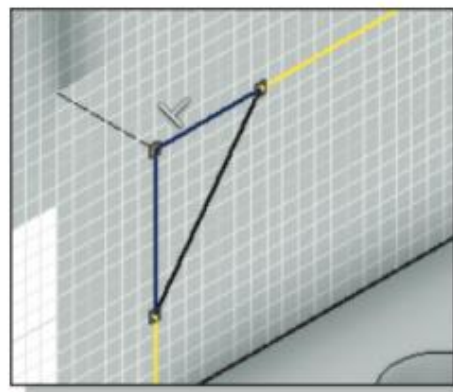

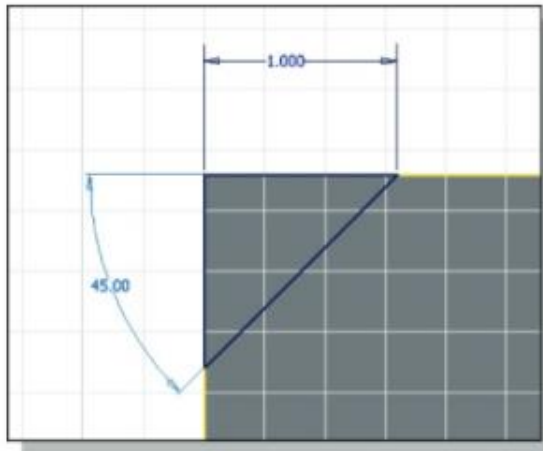

- On your own, create and modify the two dimensions of the sketch as shown in the figure. (Hint: create the angle dimension by selecting the two adjacent lines and place the angular dimension inside the desired quadrant.)

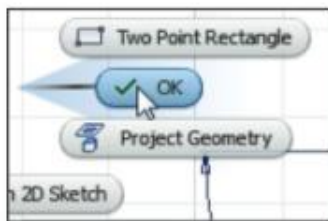

- Inside the graphics window, click once with the **right-mouse-button** to display the option menu. Select **OK** in the pop-up menu to end the **General Dimension** command.



- Inside the graphics window, click once with the **right-mouse-button** to display the option menu. Select **Finish 2D Sketch** in the pop-up menu to end the **Sketch** option.

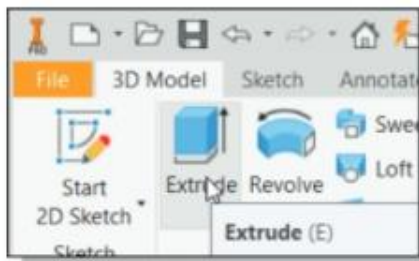

- In the **3D Model** tab, select the **Extrude** command by left-clicking the icon.

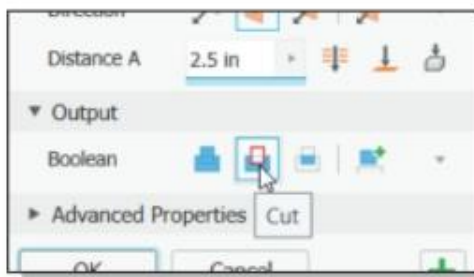

- Select the **CUT** option in the *Boolean option* list to set the extrusion operation to **Cut**.



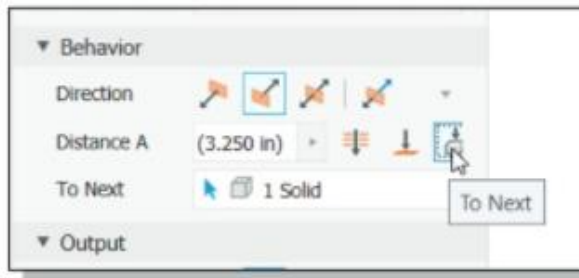

- Set the *Extents* option to **To Next** as shown. The *To Next* option instructs the software to calculate the extrusion distance and assures the created feature will always cut through the proper length of the model.

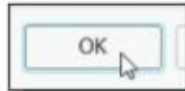

- Click on the **OK** button to proceed with creating the extruded feature.

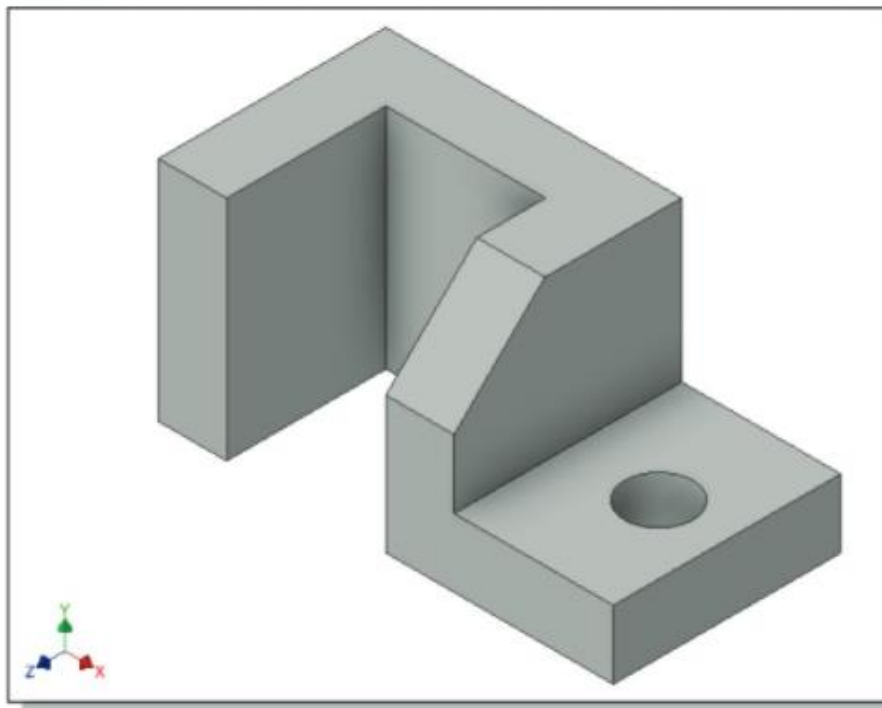

## Save the Model



- Select **Save** in the *Quick Access* toolbar, or you can also use the "**Ctrl-S**" combination (hold down the "Ctrl" key and hit the "S" key once) to save the part.

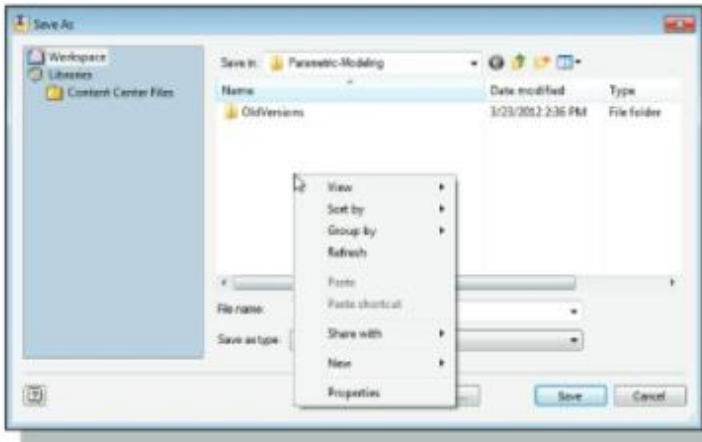

2. In the *Save As* dialog box, **right-click** once in the *list area* to bring up the *option menu*.

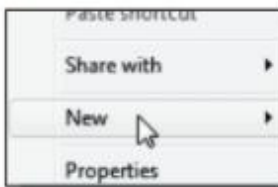

3. In the *option list*, select **New** as shown.

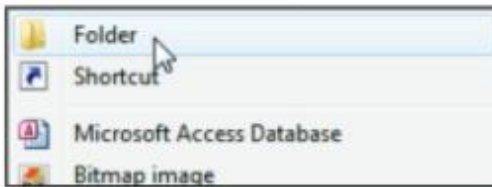

4. In the second *option list*, select **Folder** to create a subfolder.

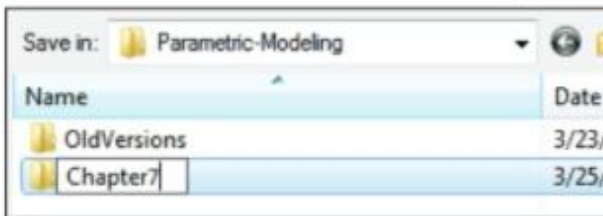

5. Enter **Chapter7** as the new folder name as shown.

6. **Double-click** on the Chapter7 folder to open it.

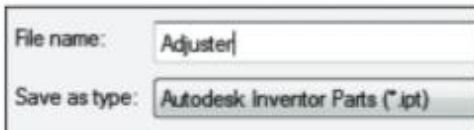

7. In the *file name* editor box, enter **Adjuster** as the file name.

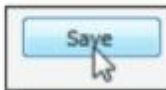

8. Click on the **Save** button to save the file.

❖ You should form a habit of saving your work periodically, just in case something goes wrong while you are working on it. In general, you should save your work at an interval of every 15 to 20 minutes. You should also save before making any major modifications to the model.

**Review Questions:** (Time: 20 minutes)

1. What is the first thing we should set up in Autodesk Inventor when creating a new model?
2. Describe the general *parametric modeling* procedure.
3. Describe the general guidelines in creating *Rough Sketches*.
4. What is the main difference between a rough sketch and a *profile*?
5. List two of the geometric constraint symbols used by Autodesk Inventor.
6. What was the first feature we created in this lesson?
7. How many solid features were created in the tutorial?
8. How do we control the size of a feature in parametric modeling?
9. Which command was used to create the last cut feature in the tutorial? How many dimensions do we need to fully describe the cut feature?
10. List and describe three differences between parametric modeling and traditional 2D Computer Aided Drafting techniques.

**Exercises:** (Time: 150 minutes. All dimensions are in inches.)

1. **Inclined Support** (Thickness: .5)

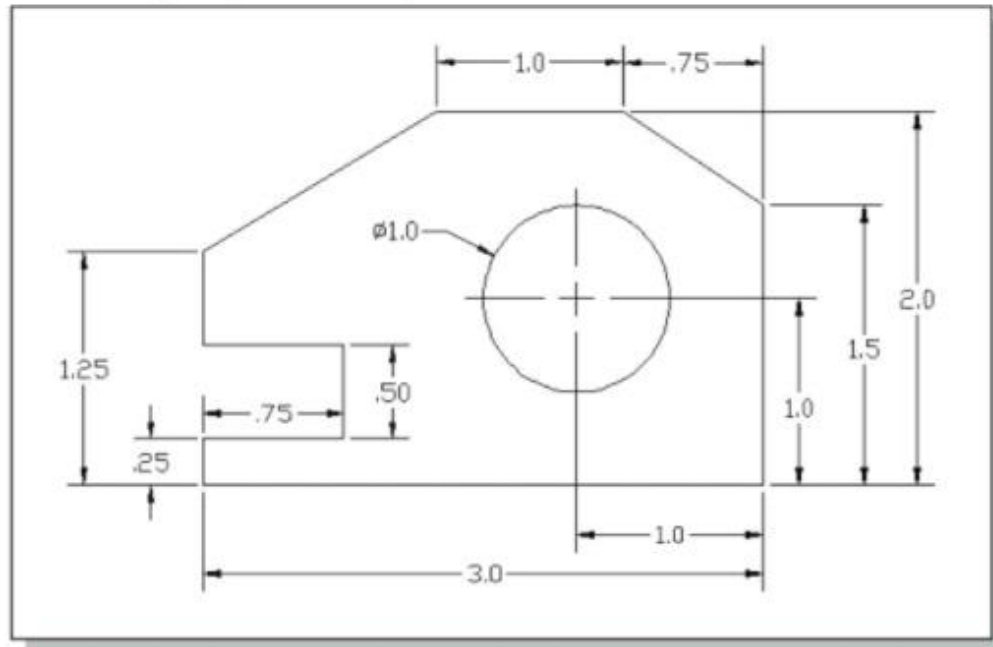

2. **Spacer Plate** (Thickness: .125)

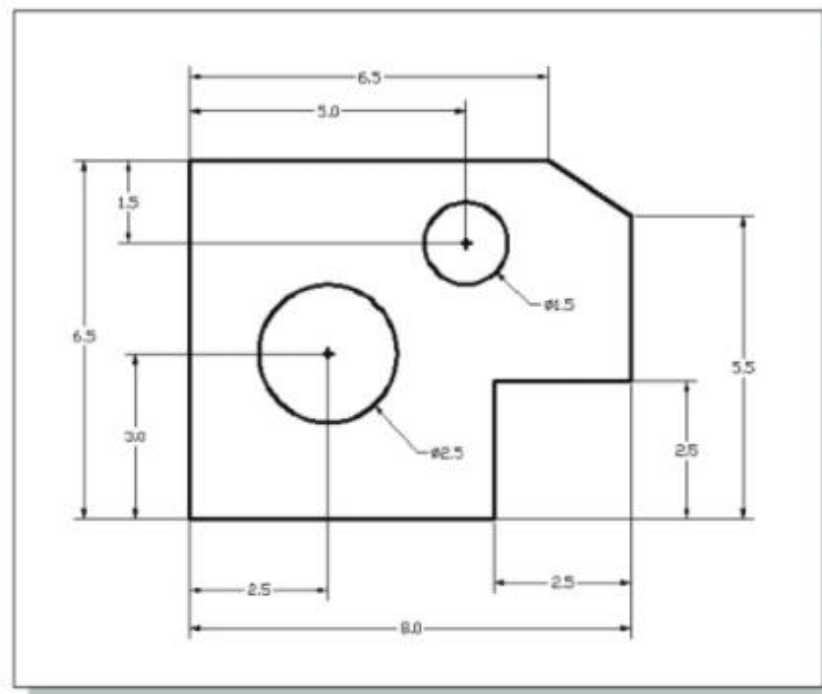



### 3. Positioning Stop

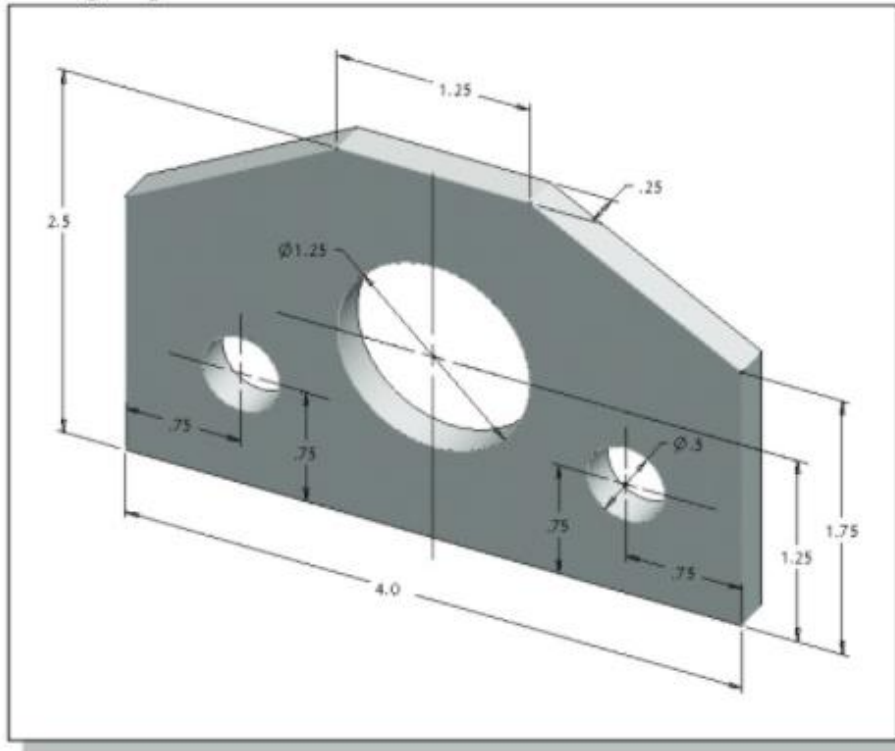

### 4. Guide Block

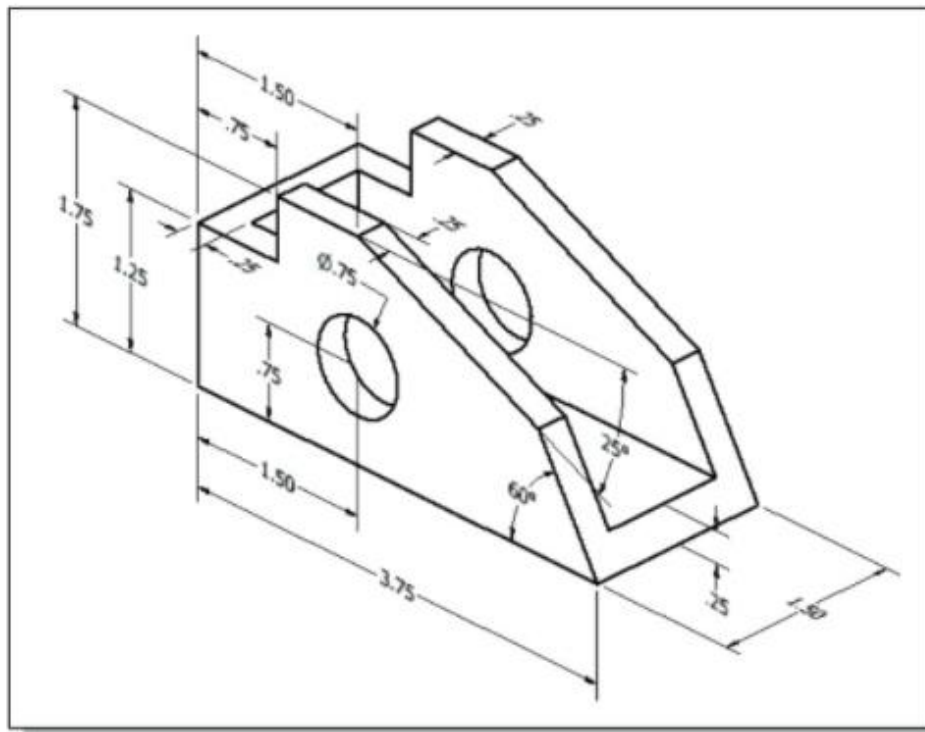

5. Slider Block

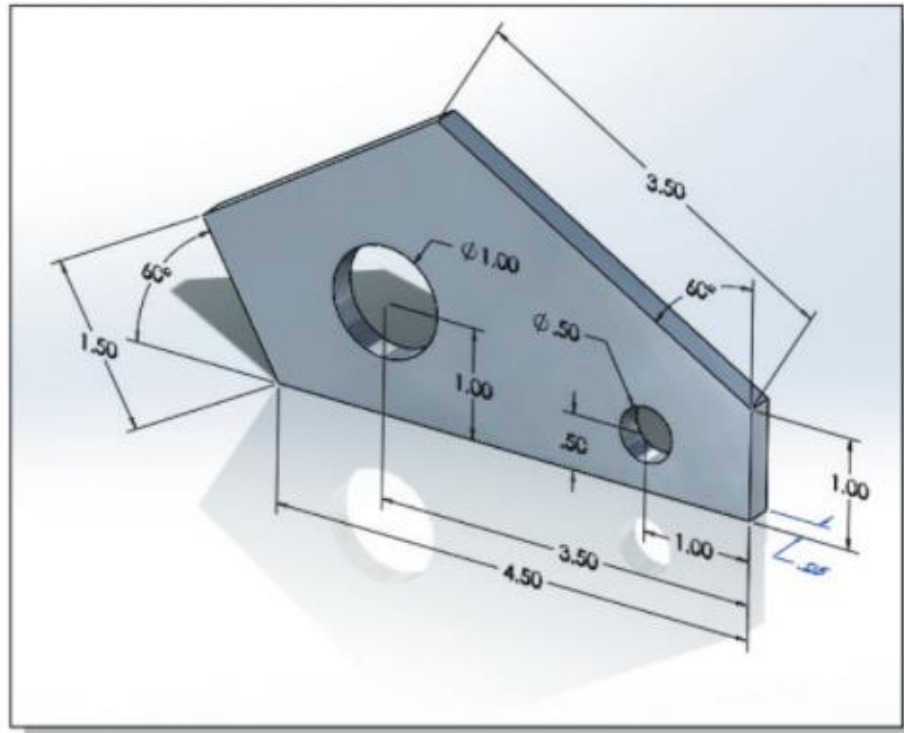

6. Circular Spacer

